

Installation guidance

Hygidoor single door and frame

Complexity:



Duration:



People:



Resources:



resources.trovex.com/hygidoor



Contents

We'd recommend familiarising yourself with all of the steps before starting the installation.

Before installation

- 1 - Storage
- Handling
- 2 - Secure fixing
- 3 - Anatomy of Hygidoor
- 4 - What's included?

Installation process

- 5 - Leaf hinges
- 6-8 - Subframe install
- 9 -10 - Leaf install
- 11 - Subframe install
Final fix
- 12 - Fire foam
- 13 - 14 - Architraves
- 15-18 - Doorstops
- 19 - Ironmongery / Sealant

After installation

- 20 - Cleaning & maintenance
 - Warranty
 - Disposal
 - Support





Storage

Hygidoor will arrive to site securely palletised, shrink wrapped and protected with a film.

-  Avoid storage conditions where extremes of temperature and humidity occur or change regularly.
-  Humidity range: 40% - 65%
Temperature range: 13 - 21 C°
-  Hygidoor should not be stored outside or in areas where it may be exposed to water or humidity.
-  Wet trades and forced-drying procedures should be complete, and the building fully dried out.
-  The protective film must remain on the Hygidoor to protect the surface finish from construction debris.
-  Door leaves are to be stored flat on a minimum of three equally spaced bearers.

Handling



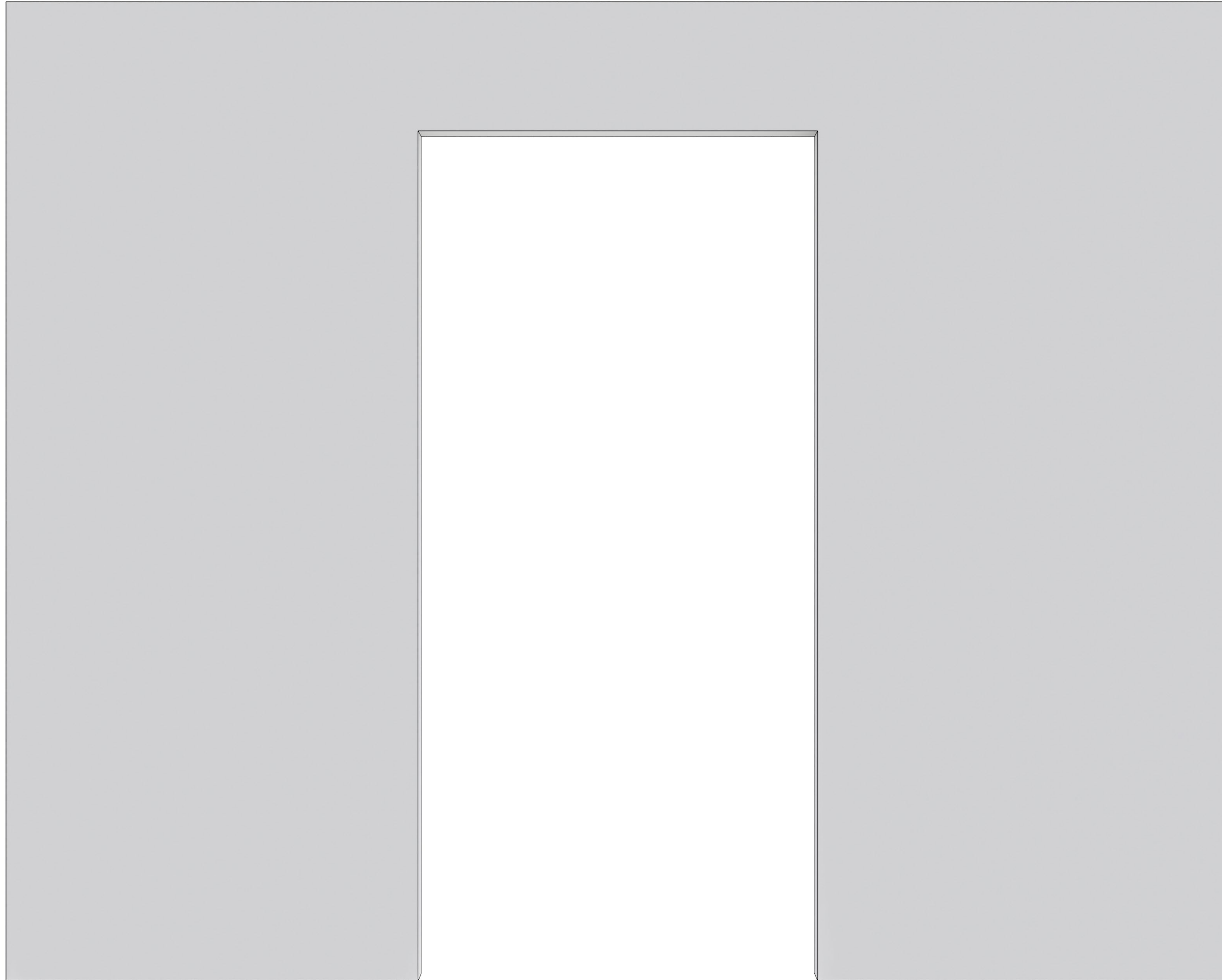

Although robust, Hygidoor still needs to be handled with care particularly on construction sites.

-  Be careful not to damage the external PVC surface during handling with blades or tools.
-  For ease of installation, due to leaf weight, we'd recommend a two person installation.
-  When distributing multiple Hygidoors across site, be sure to locate the ironmongery.
-  Allow Hygidoor to acclimatise for a minimum of 24 hours.



Secure fixing

Ensuring the structural integrity of walls is fundamental to ensuring a good and long lasting installation of the Hygidoor.

-  It is vital that the structural integrity of walls are capable of taking the dynamic and static loads.
-  Insufficient structural integrity will invalidate guarantees and cause product instability.
-  The surfaces being fixed into should be firm and stable, without defects and have good fixing retention properties over the length and width of the bearing surface.
-  Poor security of fixings will compromise performance and could lead to failure of the product.
-  Be careful not to over tighten fasteners, if using power tools make sure that the torque settings are appropriately set.

Anatomy of a Hygidoor

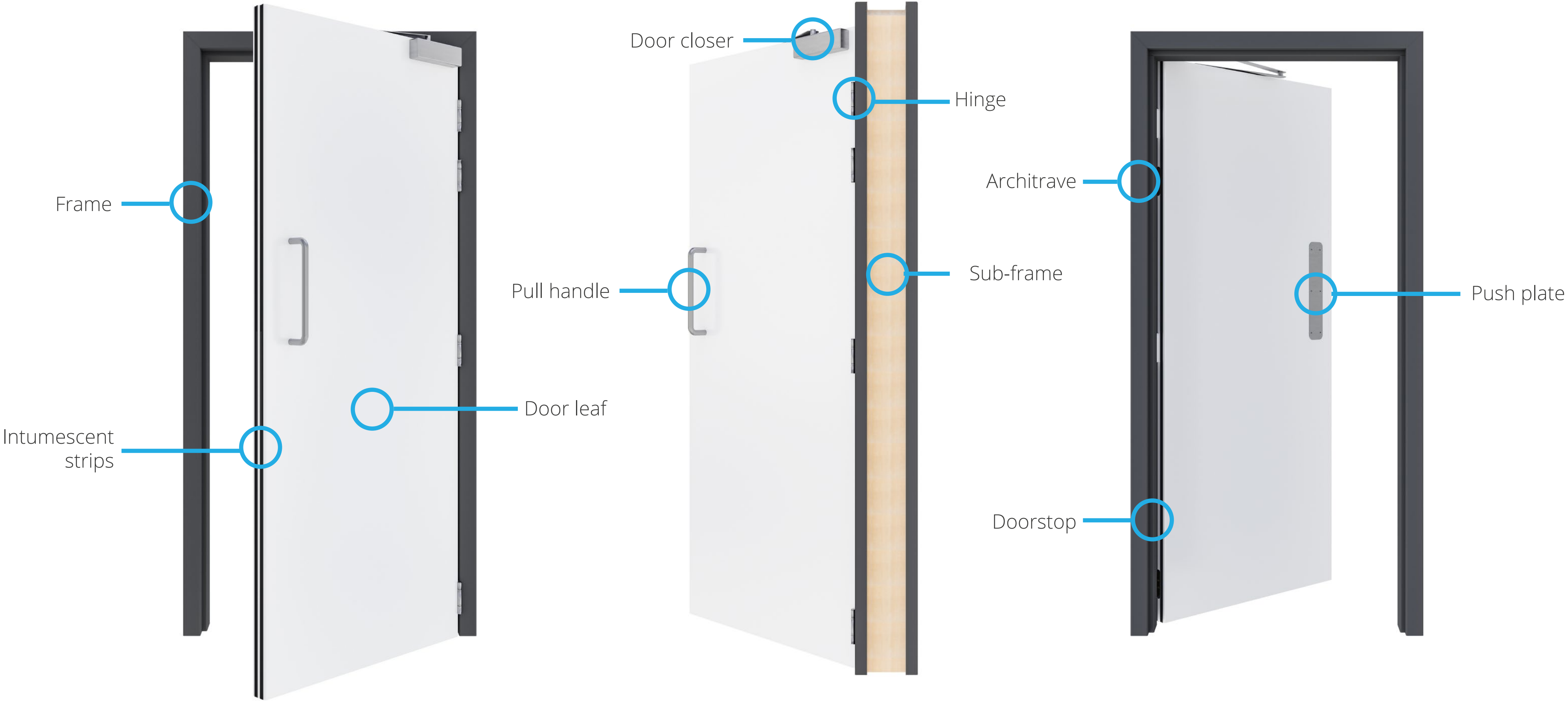

What's included?

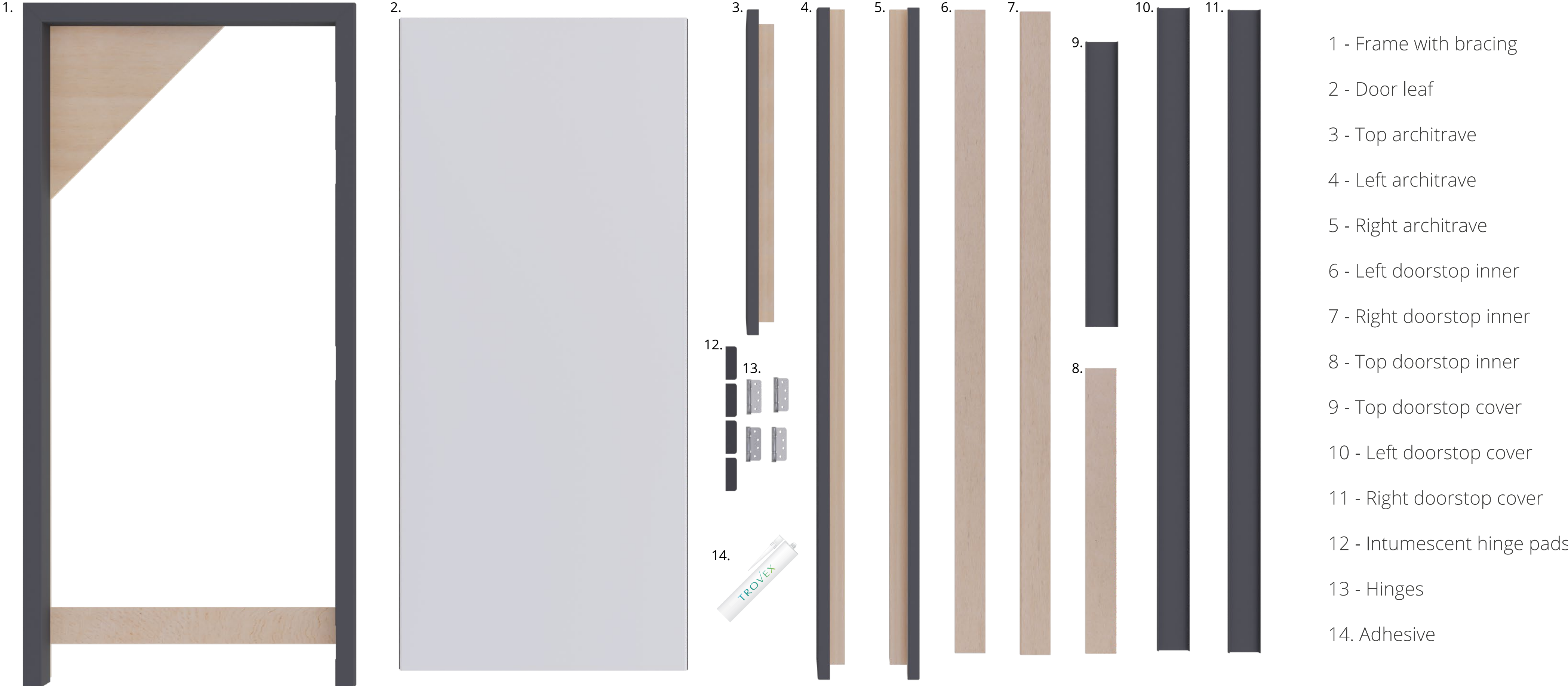

* Corner and bottom brace is for transportation only.

* Ironmongery packages will depend on specification. In this guide we show a push plate, pull handle and leaf mounted door closer.

Install hinges onto leaf

Start by unpacking the leaf, hinge packs and intumescent pads.

- Place the intumescent pads into the pre-cut rebates on the door leaf.
- Now install the hinges using the supplied fixings, careful not to over torque.
- Carefully set the leaf aside, it's time to install the frame.



Tick these as you progress!

 A non-fire or FD30 rated door will have less hinges.

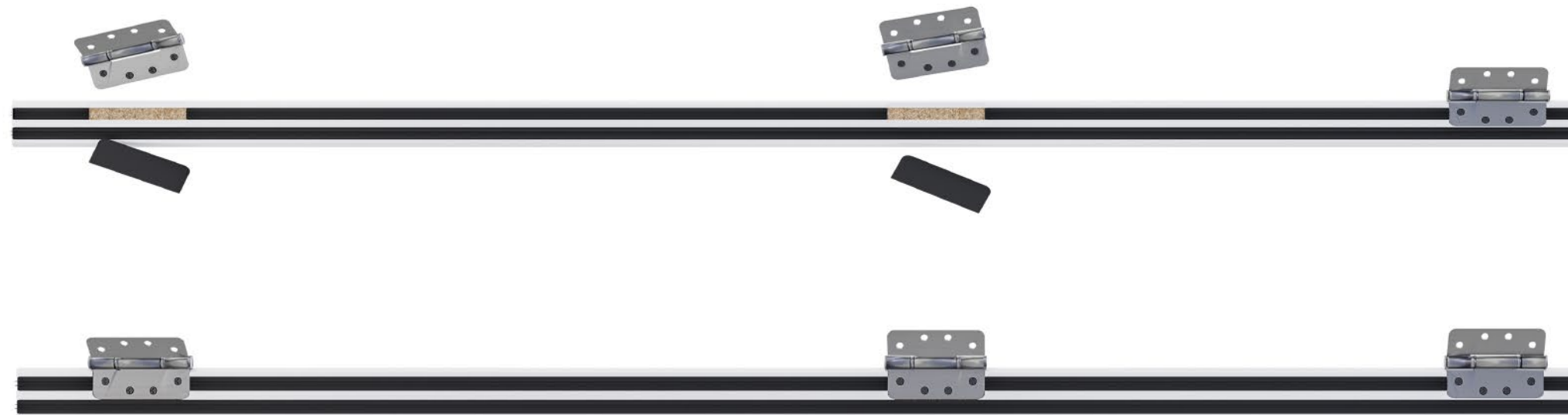

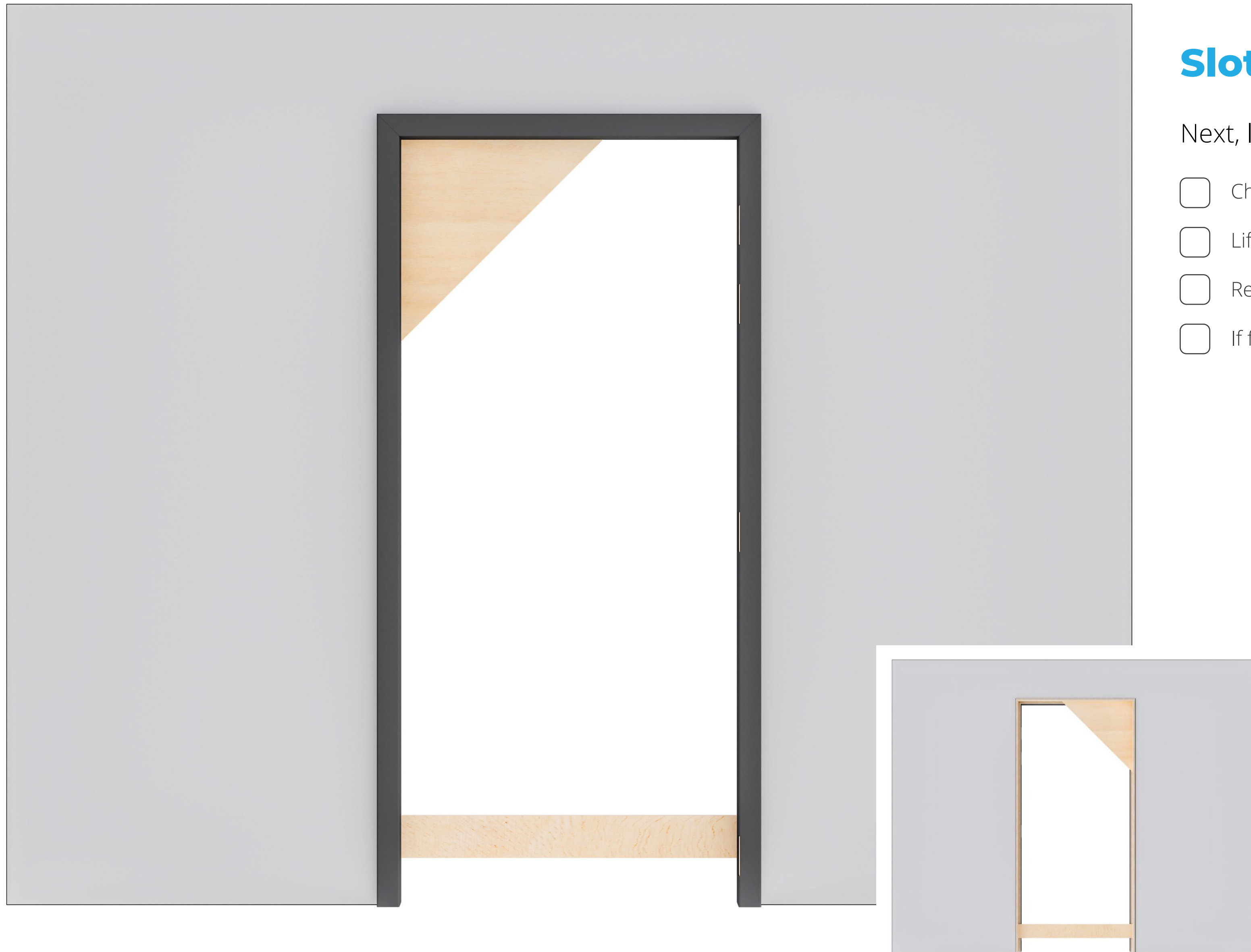

Slot in frame

Next, lift the pre-assembled frame into place.

- Check if floor is level.
- Lift the goal post frame into place.
- Remove corner brace and bottom brace.
- If floor is level, continue, if floor is not level use packers to compensate.

Secure hinge side of frame

Mark, pre-drill and secure the hinge side of frame into place.

- Mark two fixing points at each location on the jamb.
 - * Fixings need to be a maximum of 150 mm from the end of the jamb length, at 600 mm centres and next to the hinges.
- Pre-drill two holes, in the frame, at each vertical marking for your fixings.
- Pack the door away from the structural opening ensuring it is straight and square using a spirit level.

* Different packers can be used, for timber to the same density of the frame, plastic capped with intumescent mastic or intumescent packers.

- Using suitable screws, fix the frame into place frequently checking the squareness of the frame.

↪ This is important, proper fixing of the frame ensures proper hanging of the leaf.

* Minimum 6 pairs of 5.0 x 100 mm steel screws per jamb for standard 2100 high opening.

↪ See example on the right

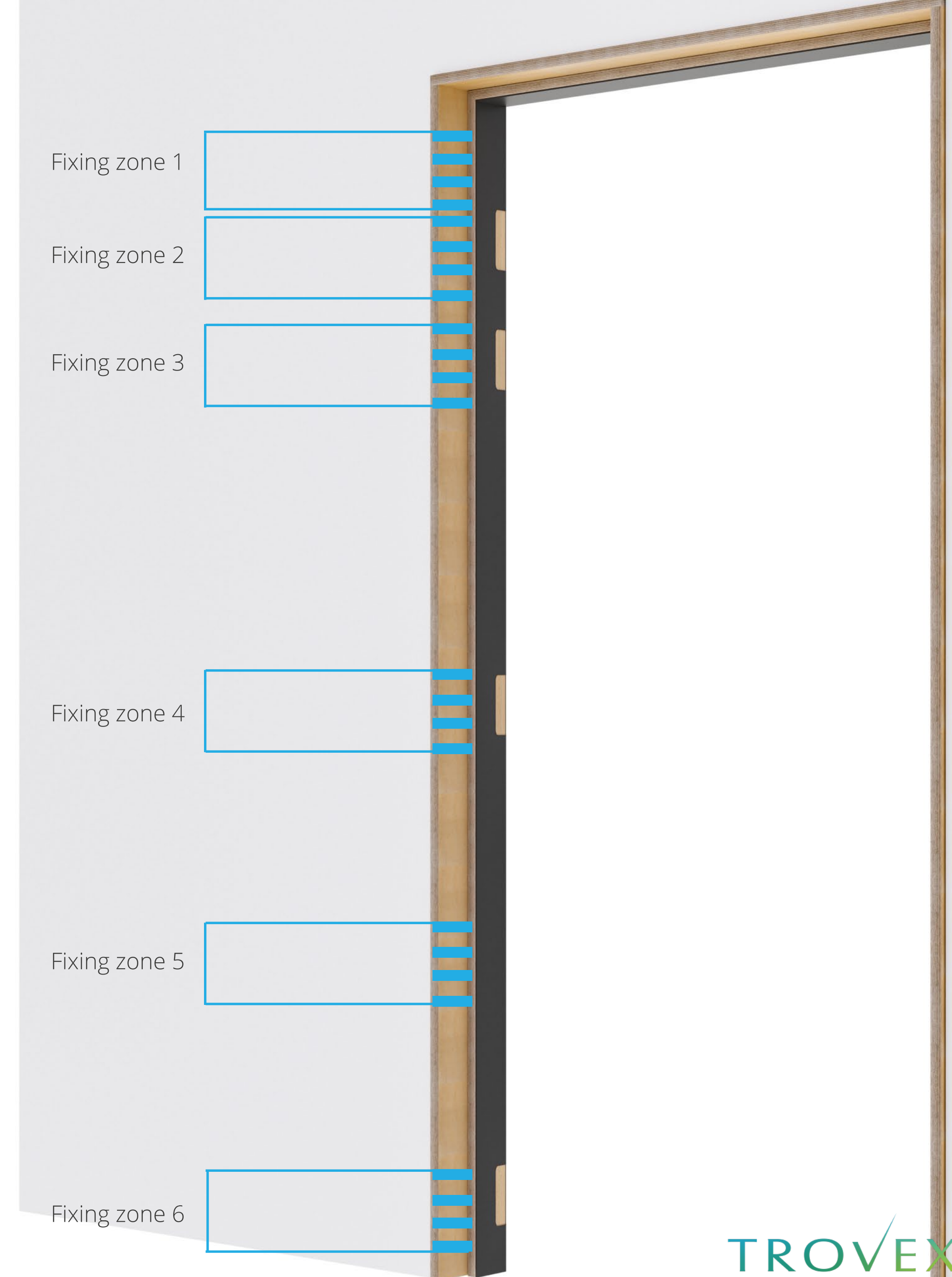

Temp fix the opposite side of frame

Pre-drill and temp fix the opposite side of the frame into place.

- Pre-drill two holes, in the frame, a maximum of 150 mm from the top and bottom and then at the centre.
- Using suitable screws (minimum 50 mm into the substrate), temporarily fix the frame into place, careful not to over tighten.

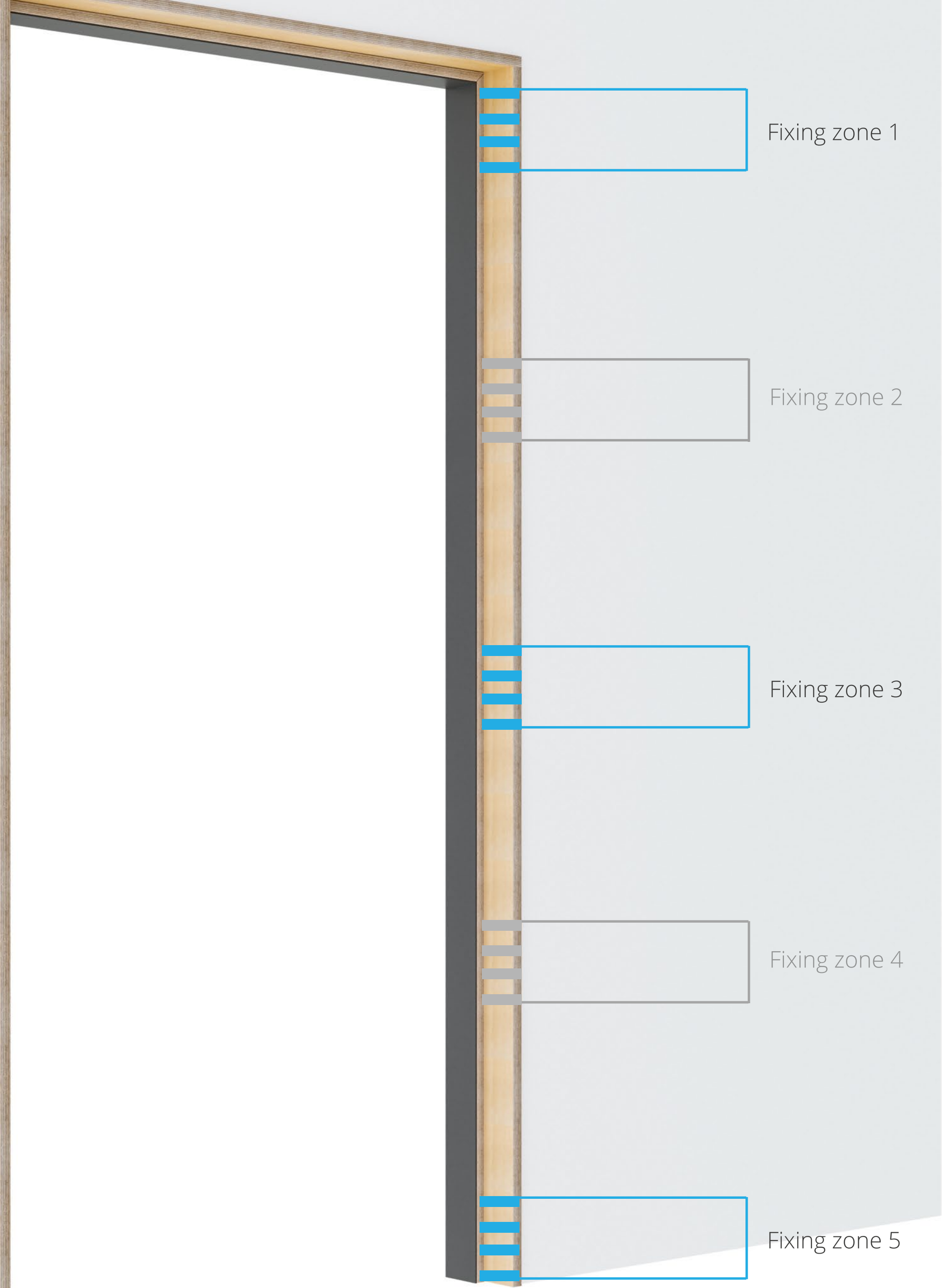



Install door leaf

Position and fix door leaf

- Lift and position the leaf at 90° to the frame and slot the hinges into the pre-cut rebates.
 - You may want to use an inflatable door lifter or a packer to align the hinges more efficiently.
- Fix the hinges in place and once secured, check the door leaf is hanging correctly by opening and closing.

Check head spacing and final fix

Ensure 3 mm gap between door leaf head and the frame

- Using a 3 mm packer, check there is the correct gap between the door leaf head and the top of the frame.
- If there is an incorrect gap at any point, pack up the jamb that is temporarily fixed. This jamb is known as the 'lock' side.

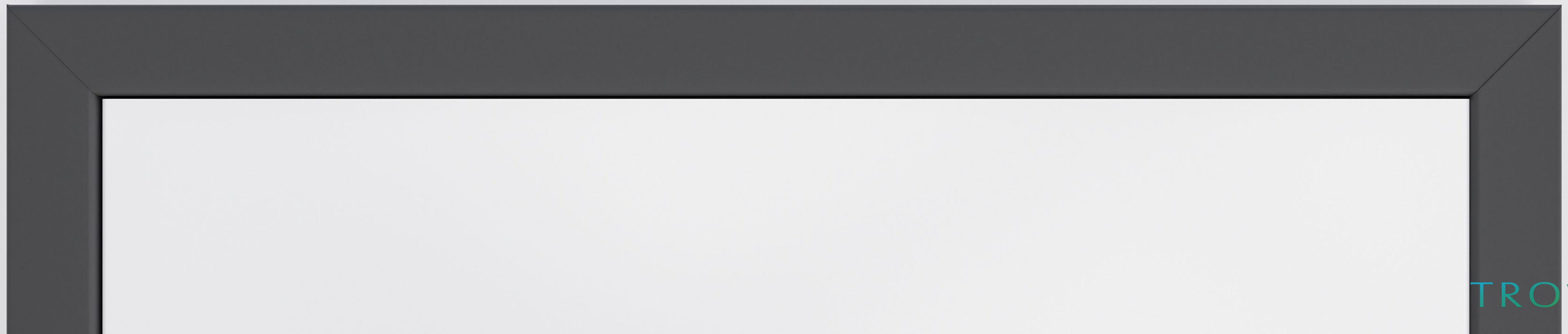
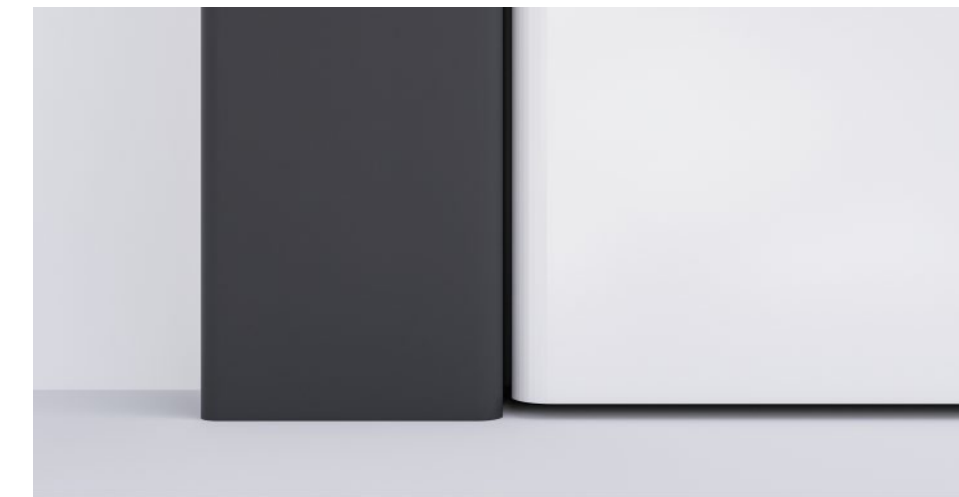

Final fix the frame

Pre-drill the remaining fixing points and secure.

- Pre-drill the remaining two fixing zones no more than 600 mm from the existing fixings.
- Using suitable length screws (minimum 50 mm into substrate) fix the jamb into place checking that it is square.
- Use packers to correct the squareness of the frame. Closing and opening the door to ensure the 3 mm gap between the leaf and the jamb is correct.

Apply fire foam

Apply fire foam between the frame and the opening.

- Using supplied fire foam, inject between the frame and the structural opening ensuring you go all of the way round.
- Once dried, cut away any excess so the fire foam finishes flush with the surface of the structural opening.
- The corner and bottom brace can now be removed.

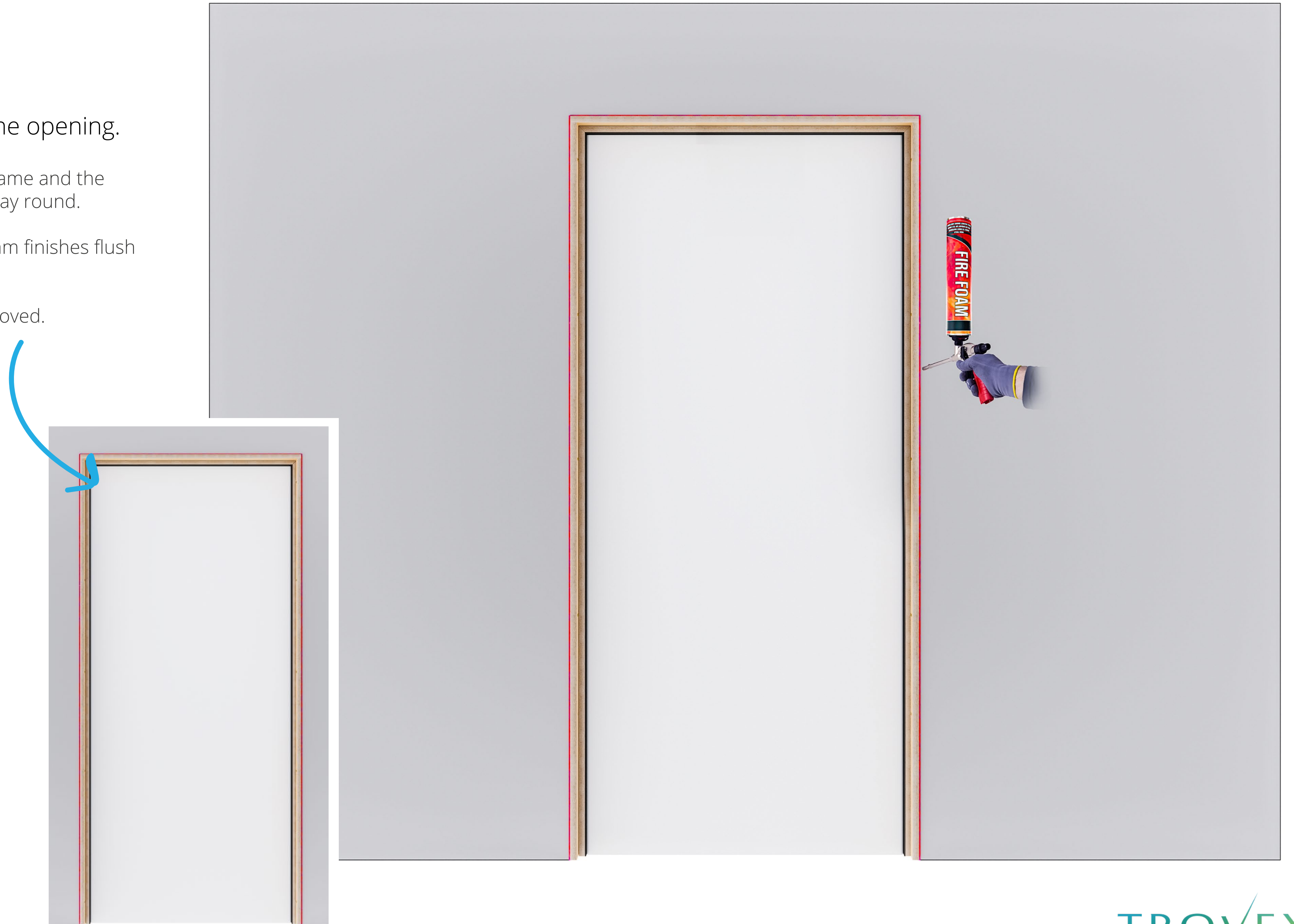

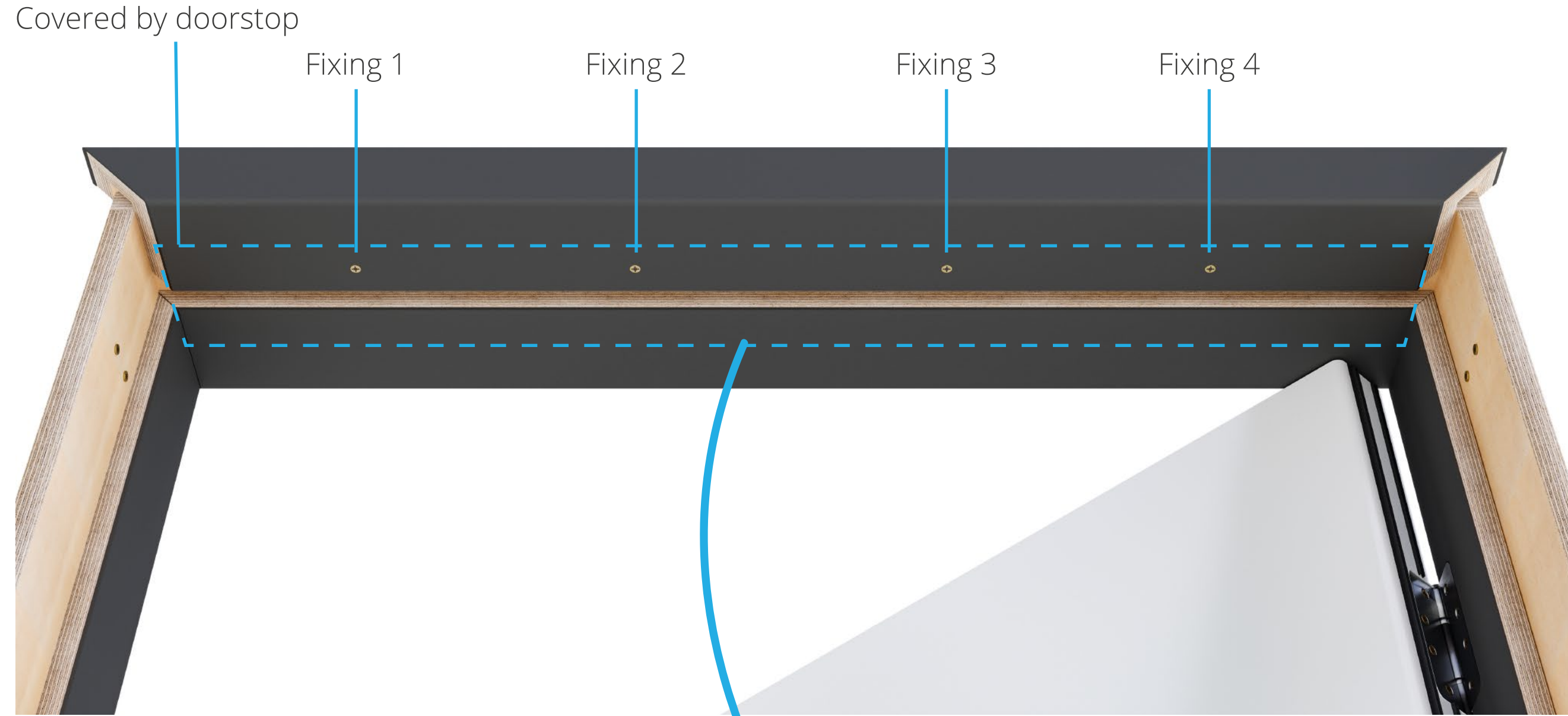

Install top architrave

Fix the top architrave into position.

Pre-drill at least 4 holes and secure the architrave in place ensuring the fixings will be covered by the door stop.

 Grab a doorstop and establish it's position before fixing the architrave in place.

Install side architraves

Fix the two side architraves in place.

- Pre-drill at least 6 holes and secure the architrave in place ensuring the fixings will be covered by the door stop.
- Apply the supplied adhesive to the mitred corner
- Repeat for the second side architrave.

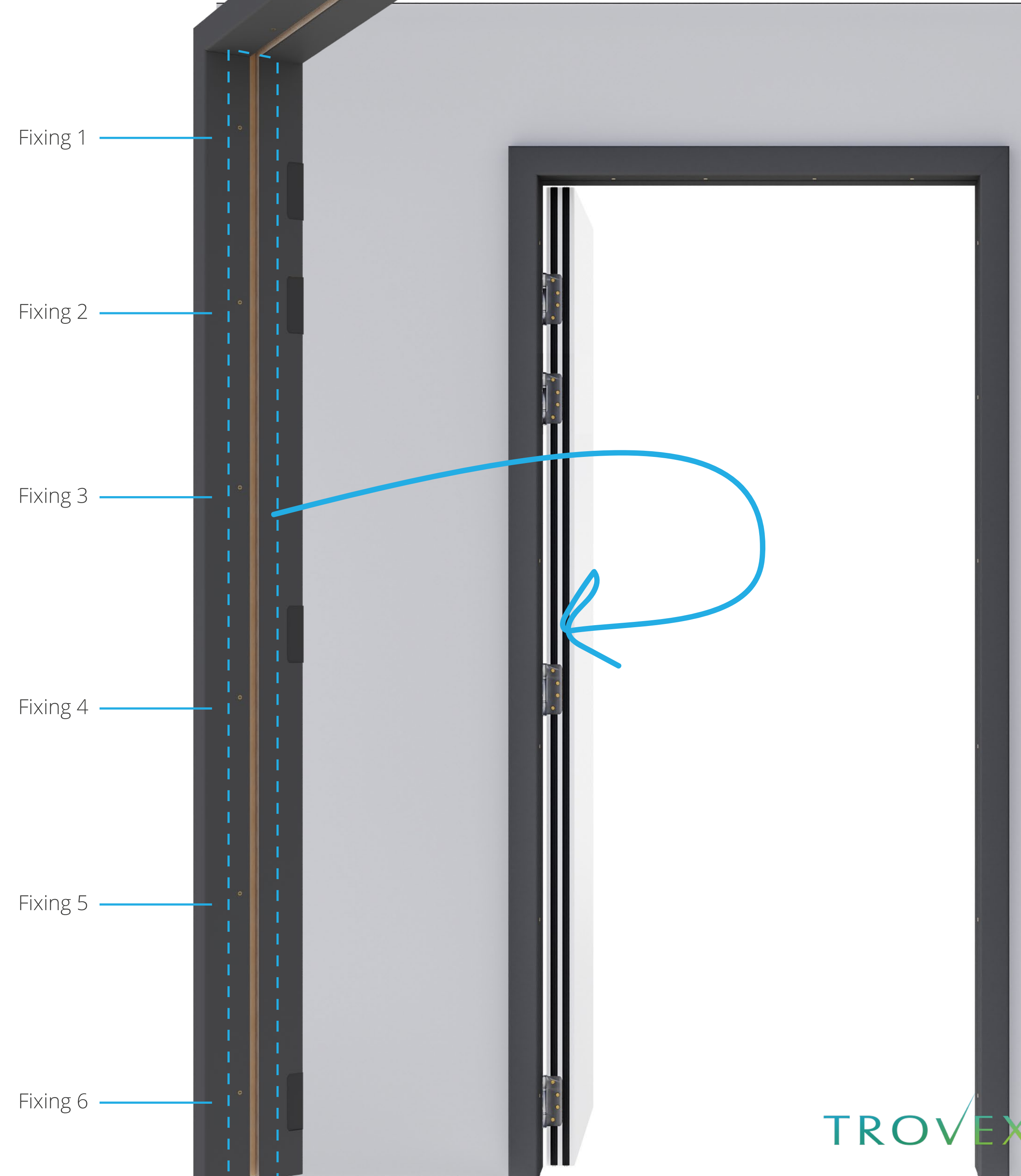

 Grab a doorstop and establish its position before fixing the architrave in place.

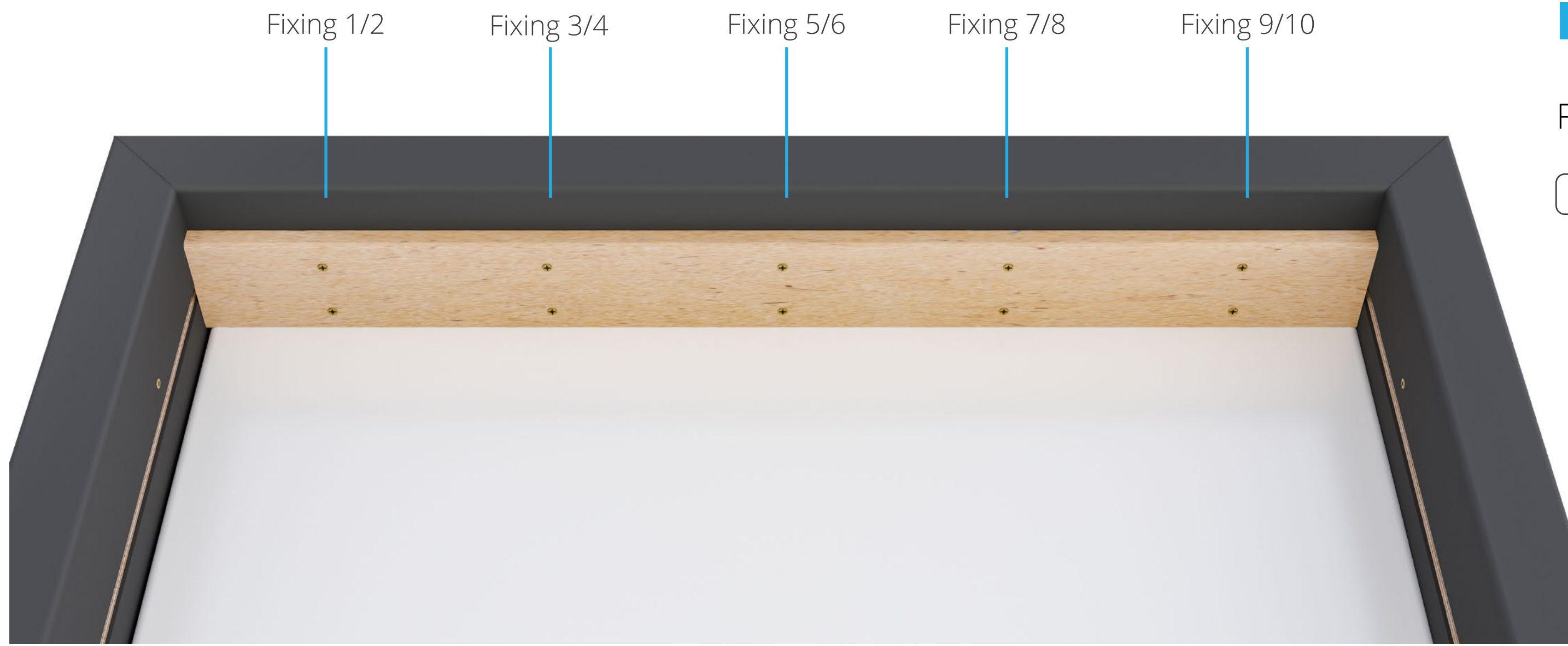



Install top doorstop

Fix the top doorstop into position.

- Using a 3 mm packer to allow space for doorstop cover between the doorstop and leaf, secure into place using 45 mm screws.
-  We'd recommend installing any locks and lock keeps before fitting the doorstops. (Eliminates any lock rattle).
-  Peel away any protective film prior to fixing the door stop.

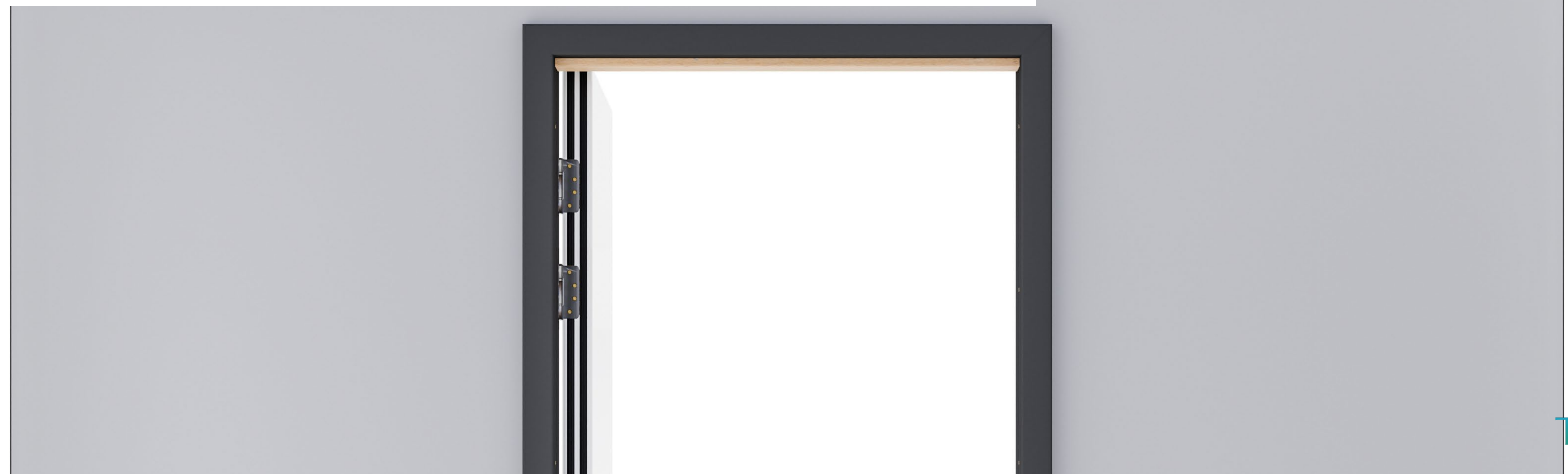

Fix top doorstop cover

Cover wooden door stop with the doorstop cover.

- In a zigzag pattern apply Trovex adhesive to the inside of the doorstop cover.
- Firmly press the doorstop cover onto the wood door stop until is secure.

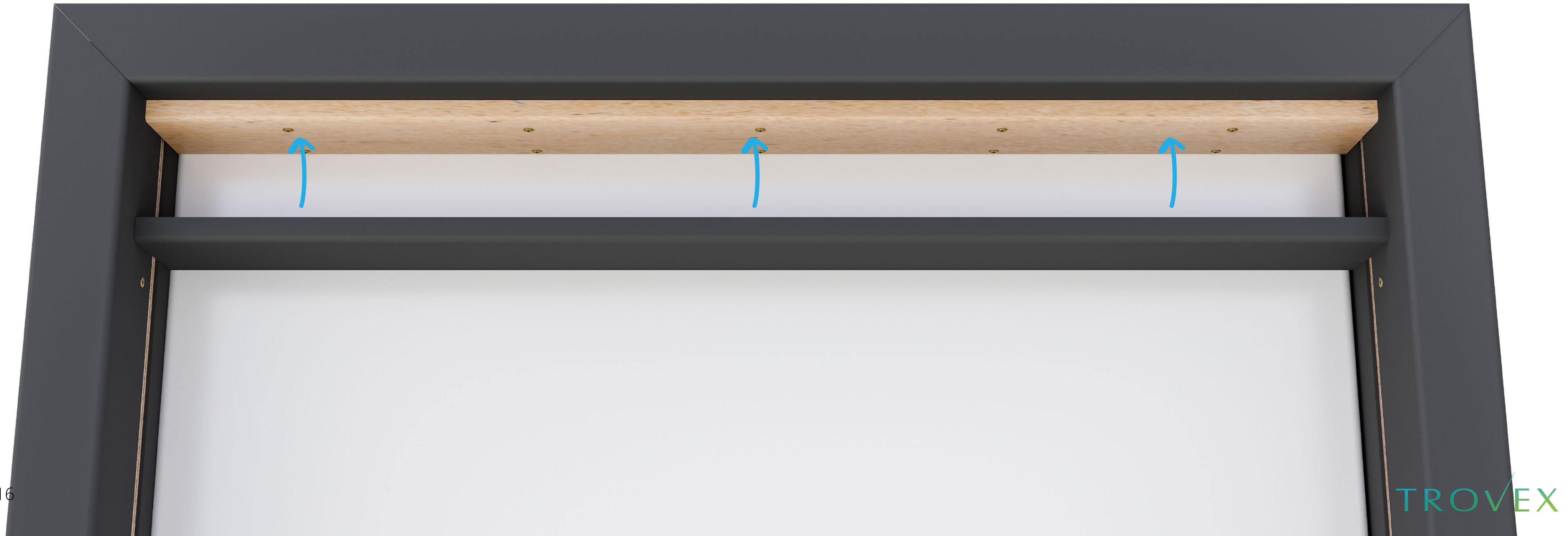

Install side doorstops

Fix the two side doorstops.

Fix the doorstops using the supplied 45 mm screws.

 Peel away any protective film prior to fixing the door stop.

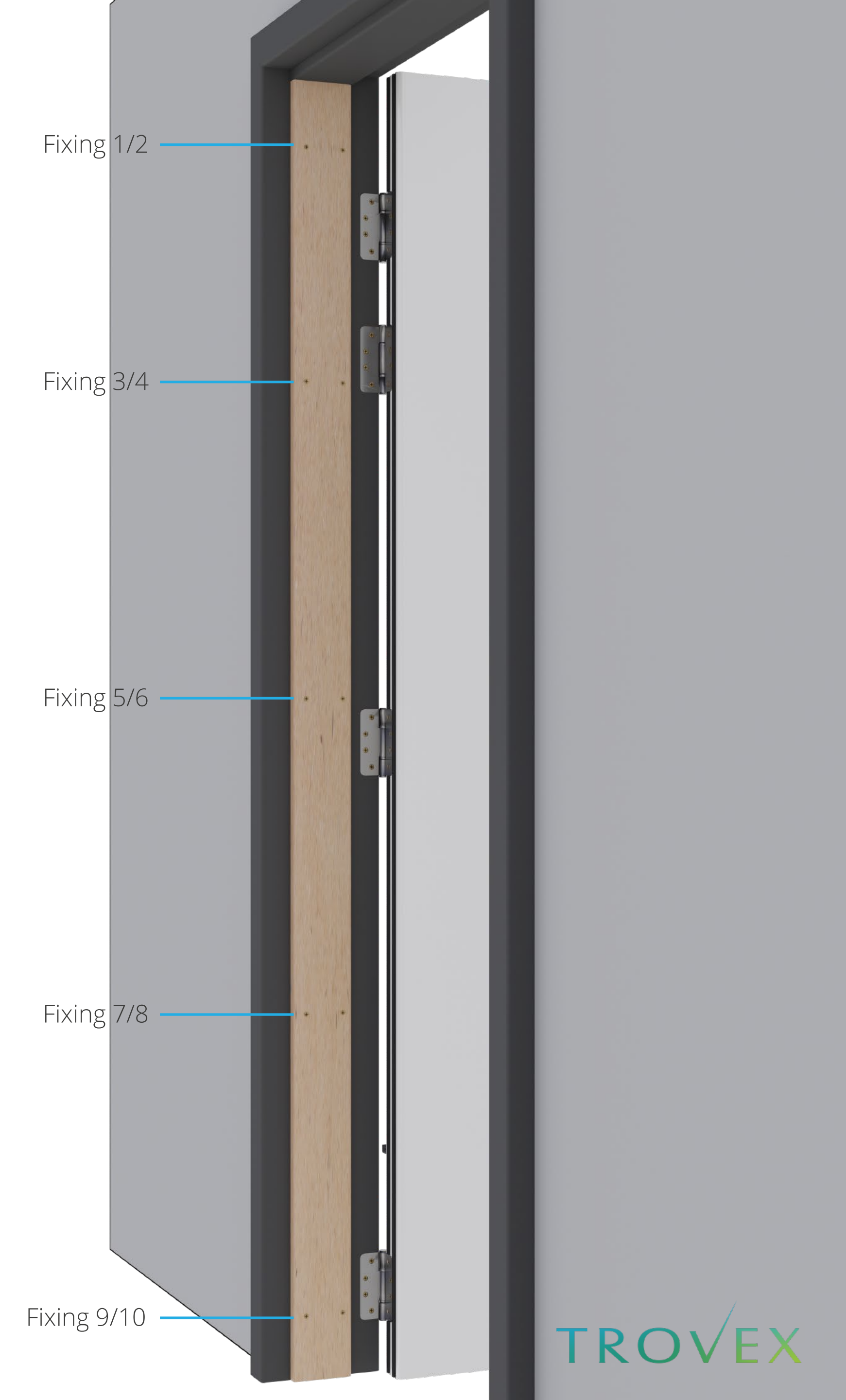

Install side doorstop covers

Fix the two side doorstop covers.

- Following the same process as the top doorstop cover, apply Trovex adhesive and firmly press both into place.



Install ironmongery

Follow ironmongery manufacturers installation guide.

- For handles, push plates and door closers follow the manufacturers installation guidance.
- At this stage you may also wish to apply colour matched sealant to the doorstop and frame.

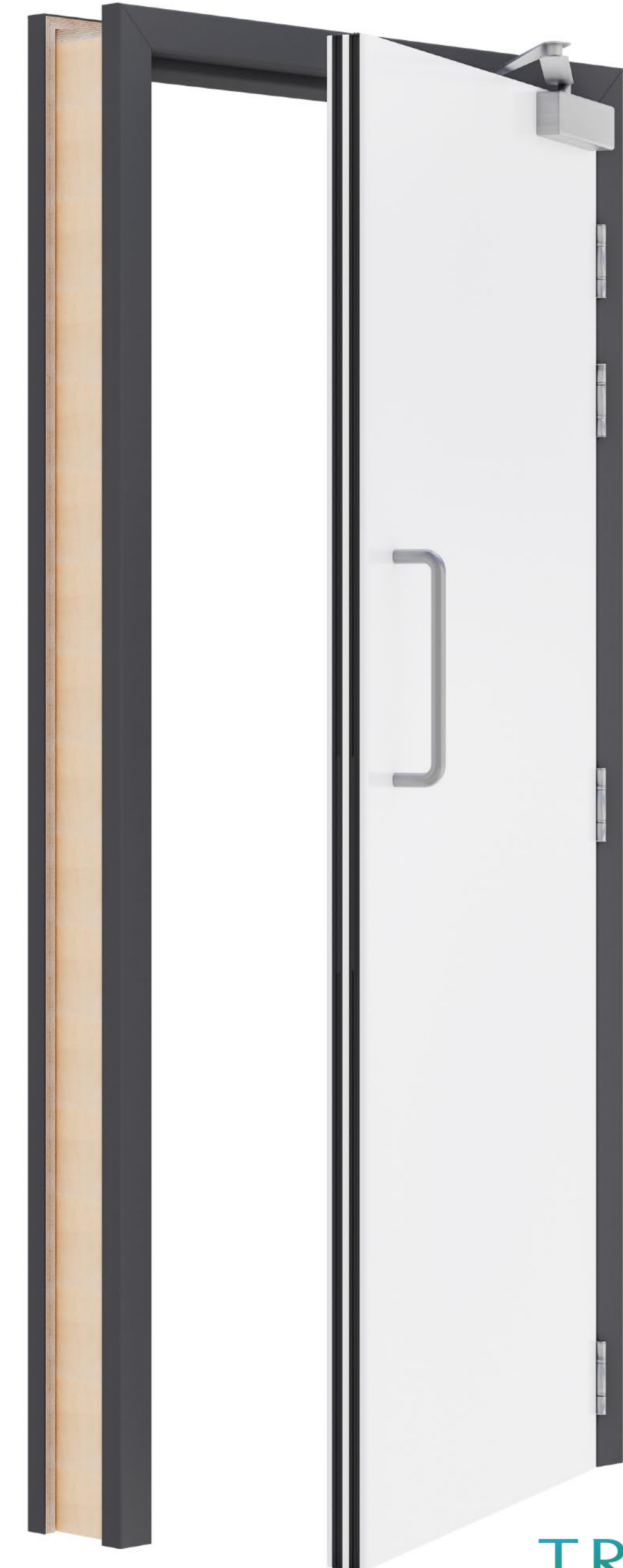

Post installation

Cleaning & maintenance

Use a soft, clean cloth dampened with a mild soap or detergent solution. Gently wipe the surface in a circular motion, ensuring to cover all areas. Avoid using abrasive cleaners or tools, as these can scratch the Hygidoor. After cleaning, rinse with clean water and dry thoroughly to prevent water spots or streaks.

For disinfection, use an approved disinfectant suitable for PVC ceramics and metals. Always wear appropriate personal protective equipment when handling cleaning chemicals. It's essential to conduct cleaning and disinfection procedures regularly to reduce the risk of healthcare-associated infections.

Disposal

Please dispose of all waste materials after installation responsibly using recycling facilities where possible.

Warranty

The Hygidoor ("the Product") is supplied with a manufacturer's warranty valid for a period of ten (10) years from the date of delivery. This warranty, which is provided by Focus Trovex LLP ("the Company"), guarantees that the Product will be free from material defects in design, workmanship, and materials under normal and proper use in accordance with the installation guidance supplied.

Should there be any issues with the Product during the warranty period, the Company commits to either repair or replace the defective product, at our sole discretion, without charge. Please note, this warranty does not cover damage or defects caused by misuse, accident, modification, unsuitable physical or operating environment, improper maintenance, or if the Product has been used in a manner for which it is not intended.

This warranty does not affect statutory rights under UK law. If a problem with this Product develops during or after the warranty period, you may be entitled to certain legal remedies under the UK Sale of Goods Act or the Consumer Rights Act.

For any warranty claims or for more information, please contact our support team.

Support

For support please contact us on the following:

hello@trovex.com

01707 254 170

Innova House,
15 Rashes' Green,
Dereham,
Norfolk,
NR19 1JG

TROVEX



www.trovex.com