

## Installation guidance

# Hygidoor single door and frame

Complexity:



Duration:



People:



This installation guide is applicable to:  
NFR, FD30 and FD60 single doorsets



Resources:

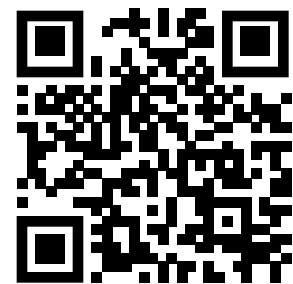

[resources.trovex.com/hygidoor](https://resources.trovex.com/hygidoor)



# Contents

We'd recommend familiarising yourself with all of the steps before starting the installation.

## Before installation

- 1 - Storage
- 2 - Secure fixing
- 3 - Anatomy of Hygidoor
- 4 - What's included?
- Handling

## Installation process

- 5 - Leaf hinges
- 6-9 - Subframe install
- 10 - Leaf install
- 11-13 - Subframe install  
Final fix
- 14-15 - Fire stopping
- 16 - 20 - Architraves
- 18-21 - Doorstops
- 22 - Ironmongery / Sealant

## After installation

- 23 - Cleaning & maintenance
  - Warranty
  - Disposal
  - Support





## Storage

Hygidoor will arrive to site securely palletised, shrink wrapped and protected with a film.

-  Avoid storage conditions where extremes of temperature and humidity occur or change regularly.
-  Temperature range: 13 - 21 C°
-  Hygidoor should not be stored outside or in areas where it may be exposed to water or humidity.
-  Wet trades and forced-drying procedures should be complete, and the building fully dried out.
-  The protective film must remain on the Hygidoor to protect the surface finish from construction debris.
-  Door leaves are to be stored flat on a minimum of three equally spaced bearers.

## Handling



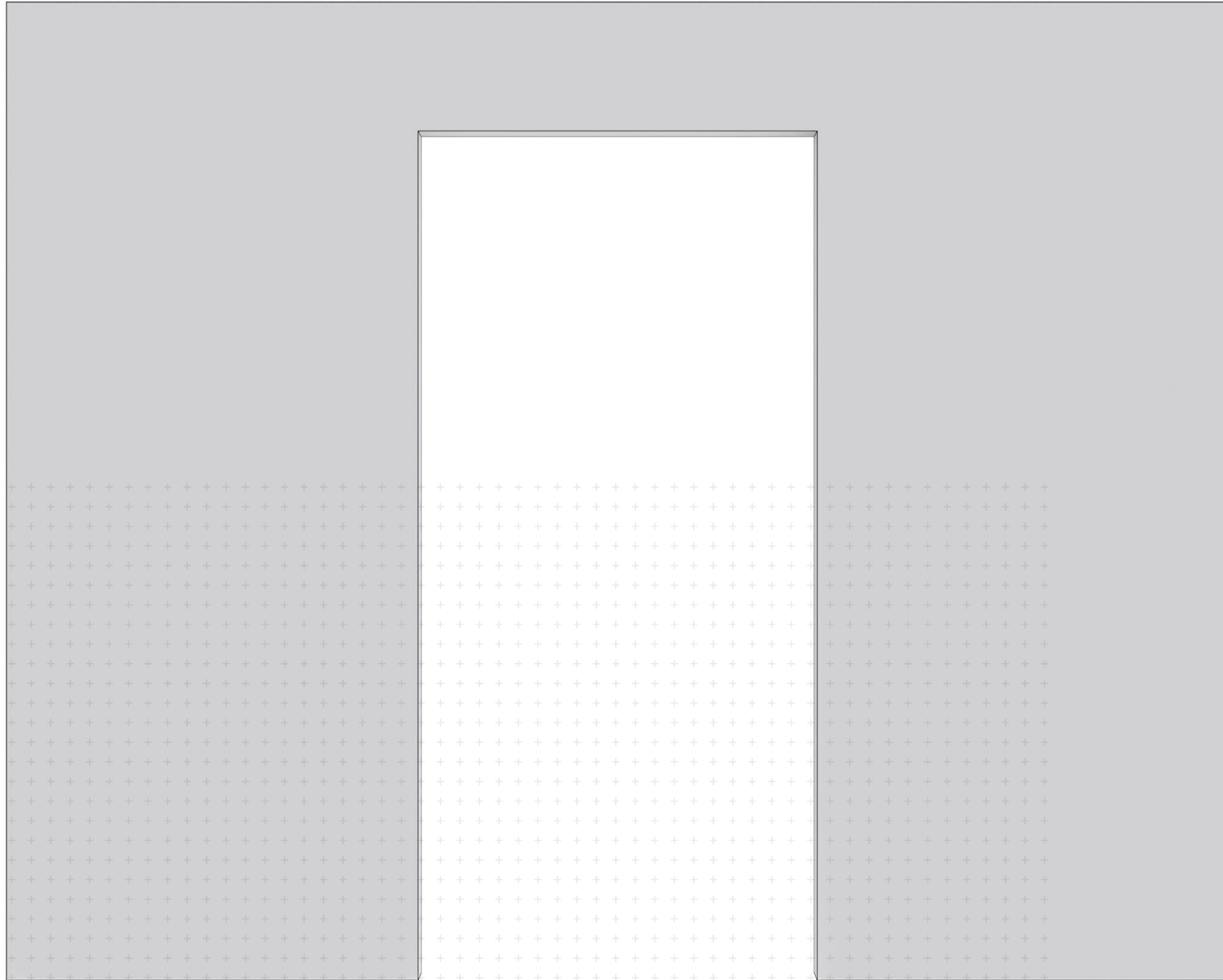

Although robust, Hygidoor still needs to be handled with care particularly on construction sites.

-  Be careful not to damage the external PVC surface during handling with blades or tools.
-  For ease of installation, due to leaf weight, we'd recommend a two person installation.
-  When distributing multiple Hygidoors across site, be sure to locate the ironmongery set for each door.
-  Allow Hygidoor to acclimatise for a minimum of 24 hours.



## Secure fixing

Ensuring the structural integrity of walls is fundamental to ensuring a good and long lasting installation of the Hygidoor.

-  It is vital that the structural integrity of walls are capable of taking the dynamic and static loads.
-  Insufficient structural integrity will invalidate guarantees and cause product instability.
-  The surfaces being fixed into should be firm and stable, without defects and have good fixing retention properties over the length and width of the bearing surface.
-  Poor security of fixings will compromise performance and could lead to failure of the product.
-  Be careful not to over-tighten fasteners, if using power tools make sure that the torque settings are appropriately set.

# Anatomy of a Hygidoor

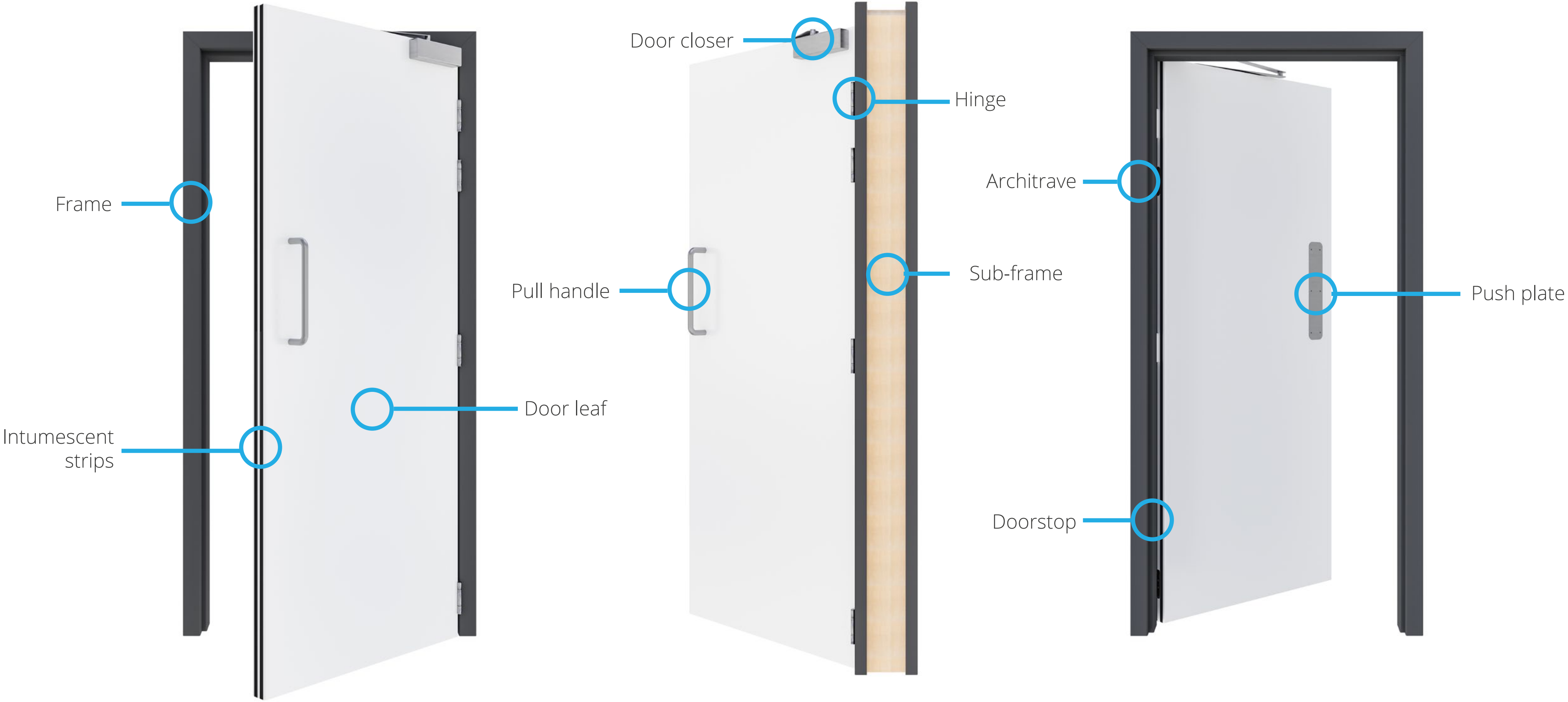

# What's included?

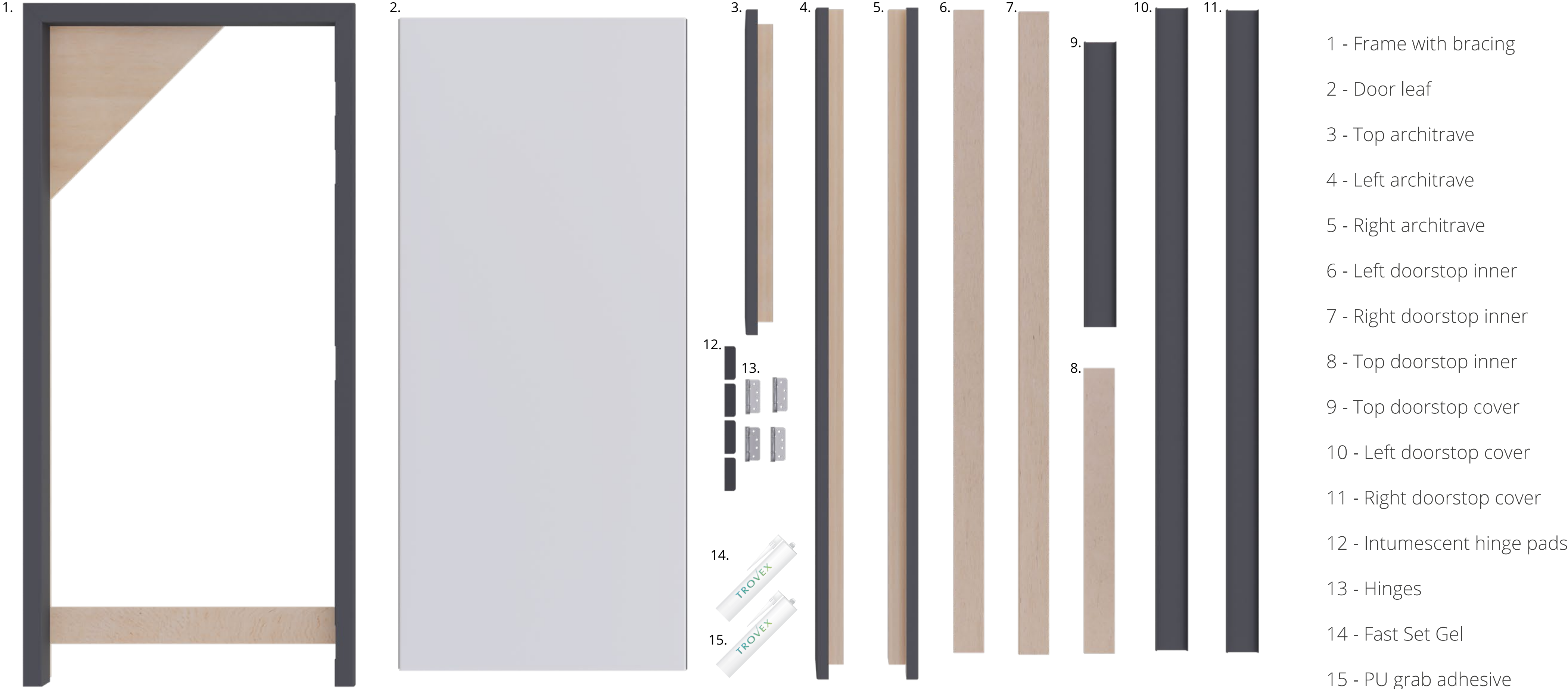

\* Corner and bottom brace must remain installed until the frame is installed into the structural opening.

\* Ironmongery packages will depend on specification. In this guide we show a push plate, pull handle and leaf mounted door closer.

## Install hinges onto leaf

Start by unpacking the leaf, hinge packs and intumescent pads.

- Place the intumescent pads into the pre-cut rebates on the door leaf.
  - \* FD30 doors require a 1 mm intumescent pad and the FD60 a 2 mm or x2 1 mm intumescent pads.
- Now install the hinges using the supplied fixings, careful not to over torque.
- Carefully set the leaf aside, it's time to install the frame.



Tick these as you progress!

- \* A non-fire or FD30 rated door will have 3 hinges and an FD60 rated door will have 4.





## Apply mastic to frame

Apply acrylic intumescent mastic to frame

- Apply an acrylic intumescent mastic bead 10 mm deep x width of the gap between the back of the frame and the structural opening.
- Set the mastic aside, we will need to use it again after adding the fire stopping material.

\* Acrylic intumescent mastic must be to BS476: Part 22: 1987 or BS EN 1634.



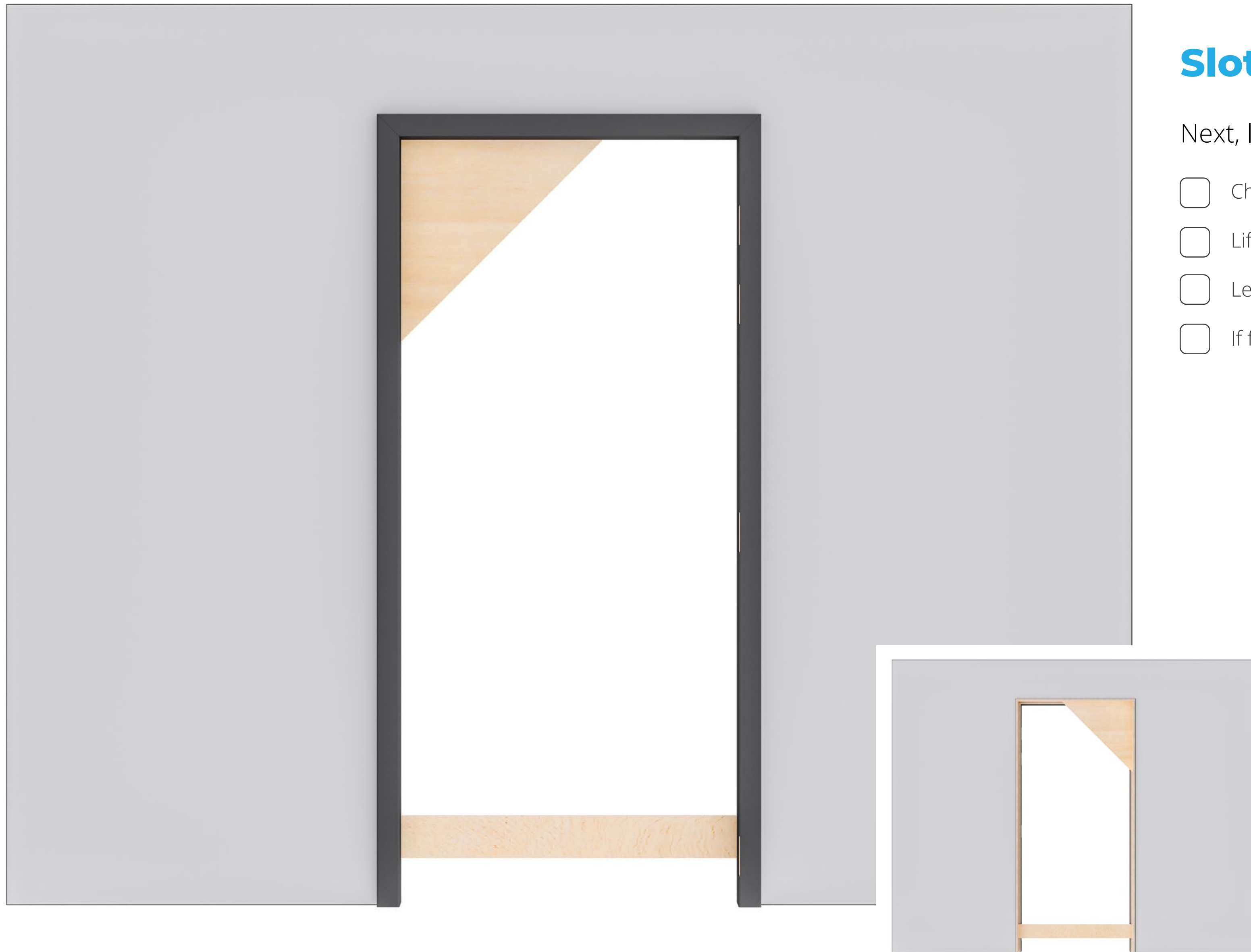

## Slot in frame

Next, lift the pre-assembled frame into place.

- Check if floor is level.
- Lift the goal post frame into place.
- Leave the corner and bottom brace attached.
- If floor is level, continue, if floor is not level use packers to compensate.

# Secure hinge side jamb

Mark, pre-drill, pack and secure the hinge side of frame into place.

- Mark two fixing points at each location on the jamb.
  - \* Fixings need to be a maximum of 150 mm from the end of the jamb length, at 600 mm centres and next to the hinges.
 

← Position so they can be covered by the doorstop.
- Pre-drill two holes, in the frame, at each vertical marking for your fixings.
- Pack the door away from the structural opening ensuring it is straight and square using a spirit level.
  - \* Timber, plastic or intumescent packers can be used. Pack away from the structural opening so fire stopping material can be added. Place packers above fixing locations to prevent pinching.
 

←
- Using suitable screws, fix the frame into place frequently checking the squareness of the frame.
  - \* Fixings must have a depth of at least 50 mm into the substrate. Minimum 5 pairs of 5.0 x 100 mm steel screws per jamb for standard 2100 high opening.
 

←



Place packers above or behind fixings ensuring the frame is pushed away from the opening for fire-stopping material to be added.

Fixing zone 1



Fixing zone 2

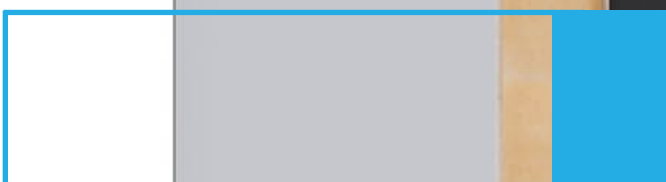

Fixing zone 3



Fixing zone 4

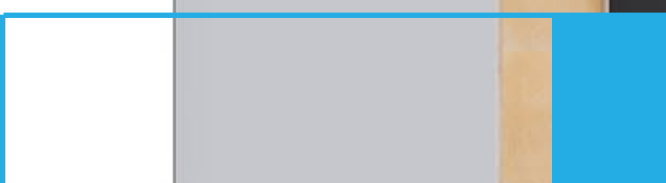

Fixing zone 5

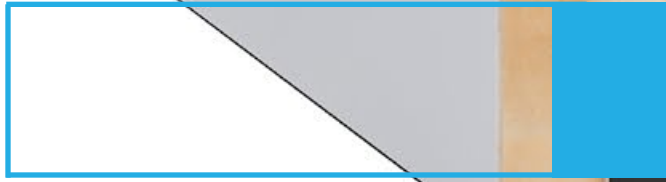

Fix into both the subframe and through the pre-fixed architrave

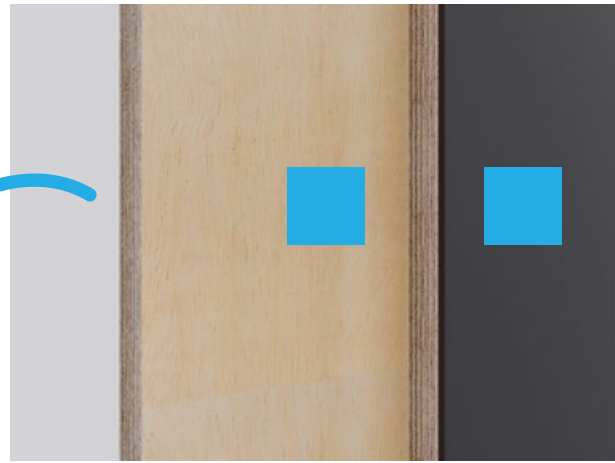

\* The fixing into the pre-fixed architrave section (PVC part) needs to be covered by the doorstop.

Mark & verify before drilling that the doorstop will cover it.

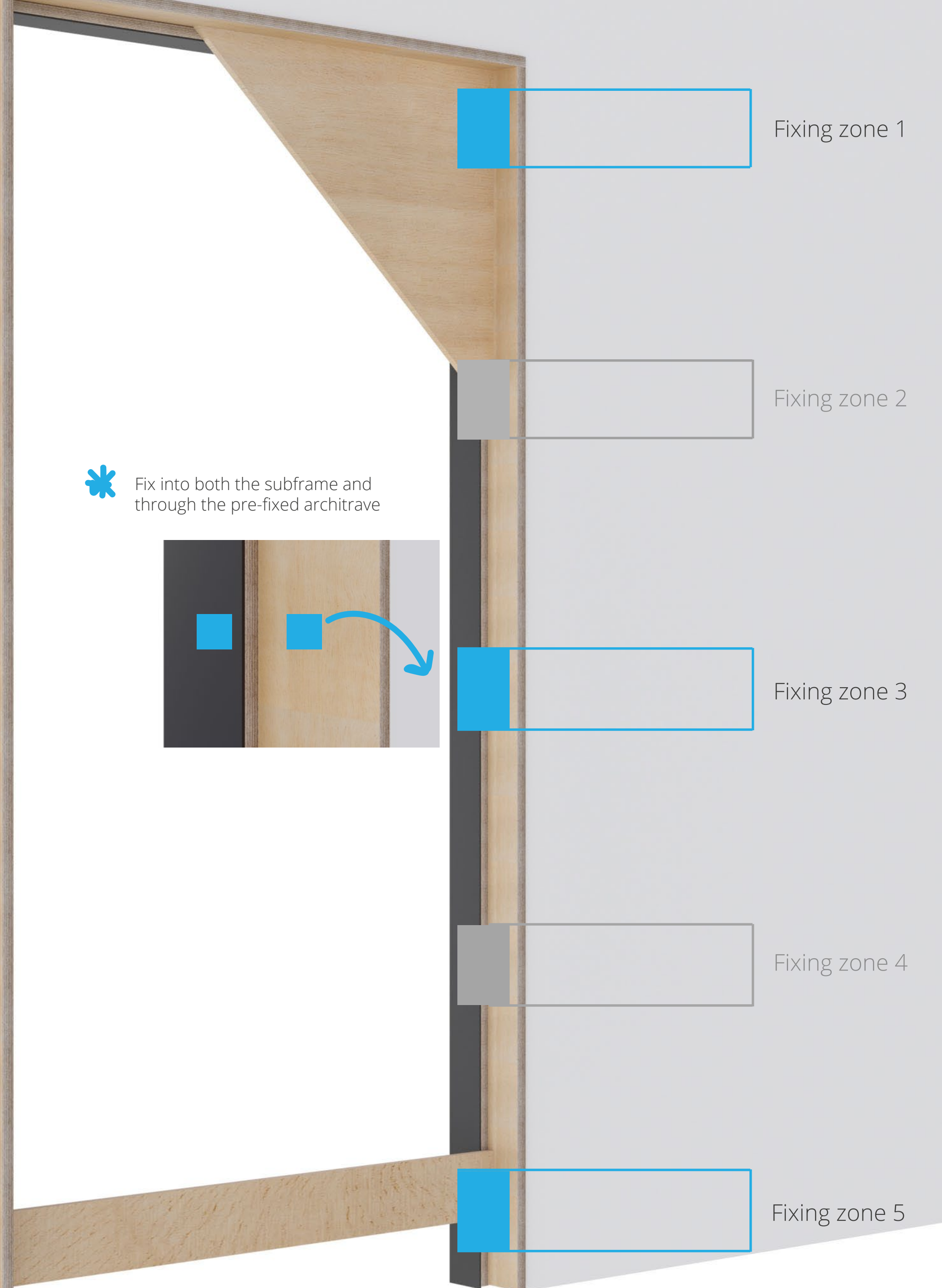

## Temp fix the opposite jamb

Pre-drill and temp fix the opposite side of the frame into place.

- Pre-drill two holes, in the frame, a maximum of 150 mm from the top and bottom and then at the centre,
- Using suitable screws (minimum 50 mm into the substrate), temporarily fix the frame into place, careful not to over tighten.
- The corner and bottom brace can now be removed.

\* At this stage you may wish to fix in zones 1, 3 and 5. You can secure the other zones once the door hangs square.

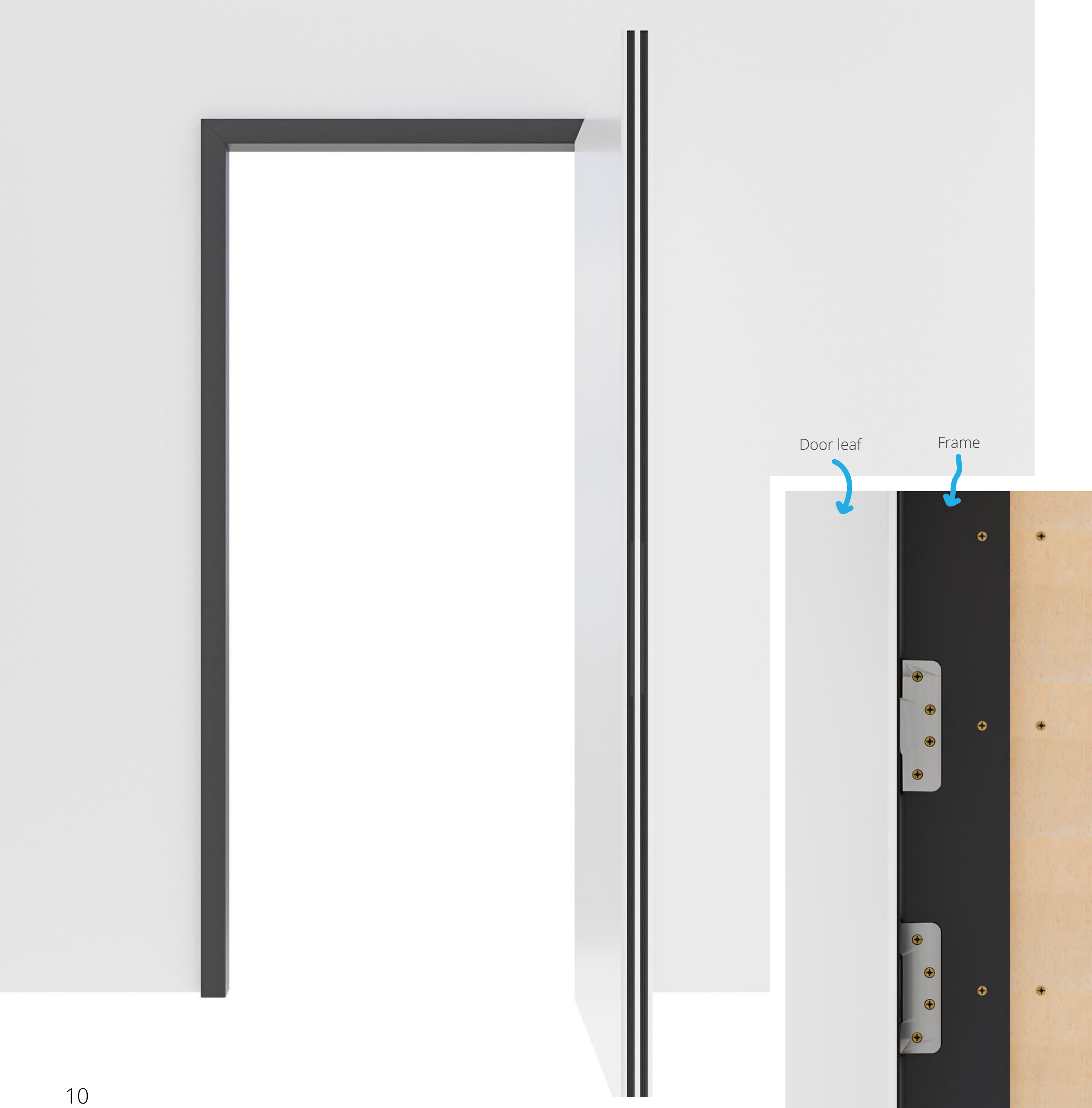

## Install door leaf

### Position and fix door leaf

- Lift and position the leaf at 90° to the frame and slot the hinges into the pre-cut rebates.
  - You may want to use an inflatable door lifter or a packer to align the hinges more efficiently.
- Slot the door leaf hinges into the frame and secure them with a couple of screws in each hinge.
- Adjust the frame by adding and removing packers as necessary to ensure the door operates evenly and maintains gaps of 2-4 mm around the leaf.
- Once the frame is confirmed to be square, fully secure the hinges with all remaining screws.

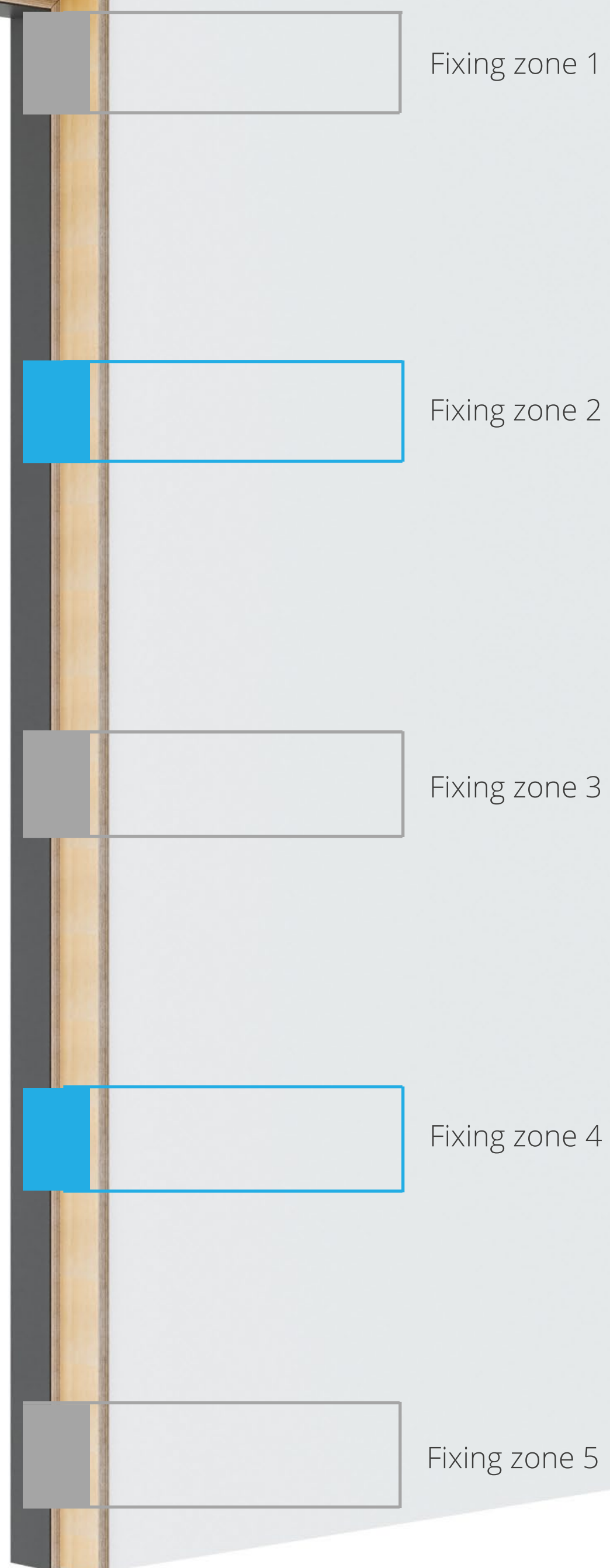

## Final fix the jamb

Pre-drill the remaining fixing points and secure.

Pre-drill the remaining two fixing zones no more than 600 mm from the existing fixings.

- Using suitable length screws (minimum 50 mm into substrate) fix the jamb into place checking that it is square.
  - Use packers directly above fixings to prevent pinching and to maintain squareness.
- Close and open the door to ensure there is a 2-4 mm gap between the leaf and the frame. Use packers to correct the squareness of the frame.

## Fix the frame head

Secure frame head in place

- One fixing is sufficient, but for extra stability fix the frame head in place with 2 fixings evenly spaced apart (minimum 50 mm into the substrate).
- Use packers next to or at the fixing point to prevent pinching.
- Check squareness and adjust if needed.

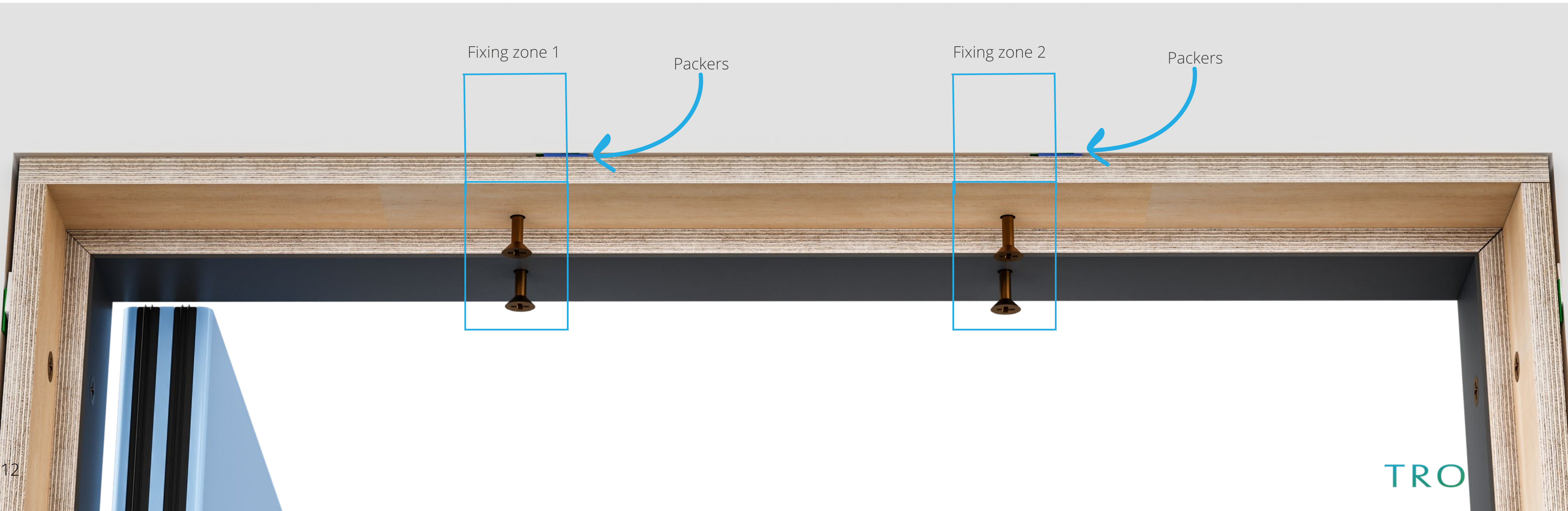

## Check leaf and frame spacing and final fix

Ensure 2-4 mm gap around door leaf and the frame

- Using a packer or door gap checker, check there is the correct gap around the door leaf and frame.
- If there is an incorrect gap at any point, temporarily unscrew where needed and introduce or remove packers as required.

2-4 mm gap

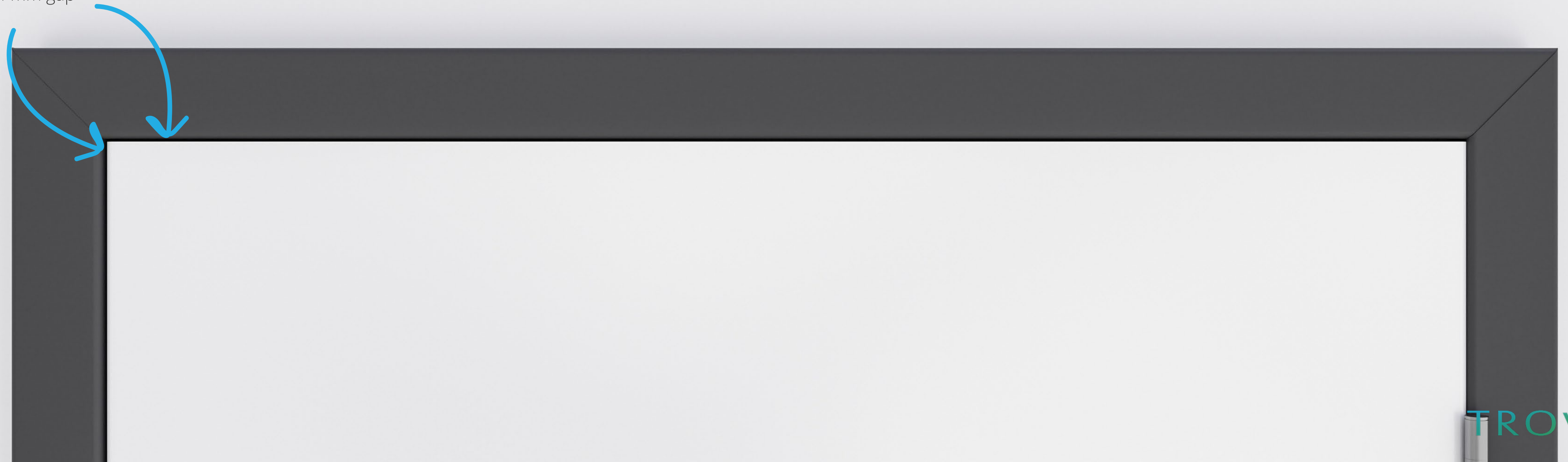

# FD30 fire-stopping

Apply fire foam between the frame and the substrate

- Insert the foam applicator with flexible nozzle deep into the void to ensure full filling.
  - \*** Only use Trovex supplied or approved foam. Use of alternative or unauthorised foam may invalidate certification.
- Trim off excess after partially setting and compress by 10 mm depth.
- Apply a 10 mm deep bead of acrylic intumescent mastic on top of the fire-foam all the way around between the frame and the substrate to seal.



**X** Mineral wool or Rockwool can be used as an alternative to fire-foam on FD30 installations. The mineral wool needs to have been tested to the correct standard. BS 476 Part 22:1987 or BS EN 1634-1. For additional information, refer to the Fire Stopping section in the Field of Application reports

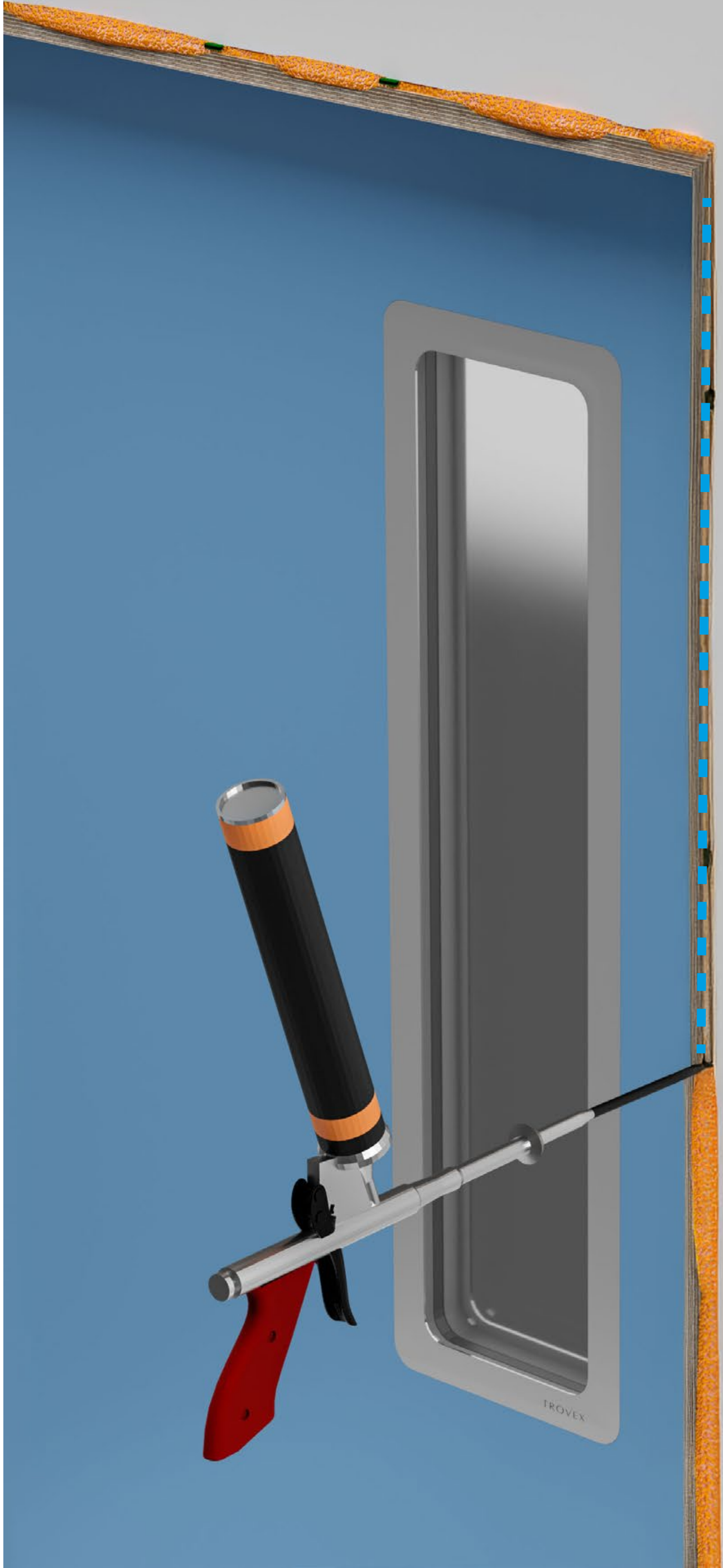

**X** Ensure fire foam fills the complete void between the frame and substrate.



# FD60 fire-stopping

Apply mineral wall between the frame and the substrate

- Densely pack the mineral fibre into the void, leaving a 10 mm deep void.
- Apply a 10 mm bead of acrylic intumescent mastic on top of the fire-foam all the way around the frame to seal.

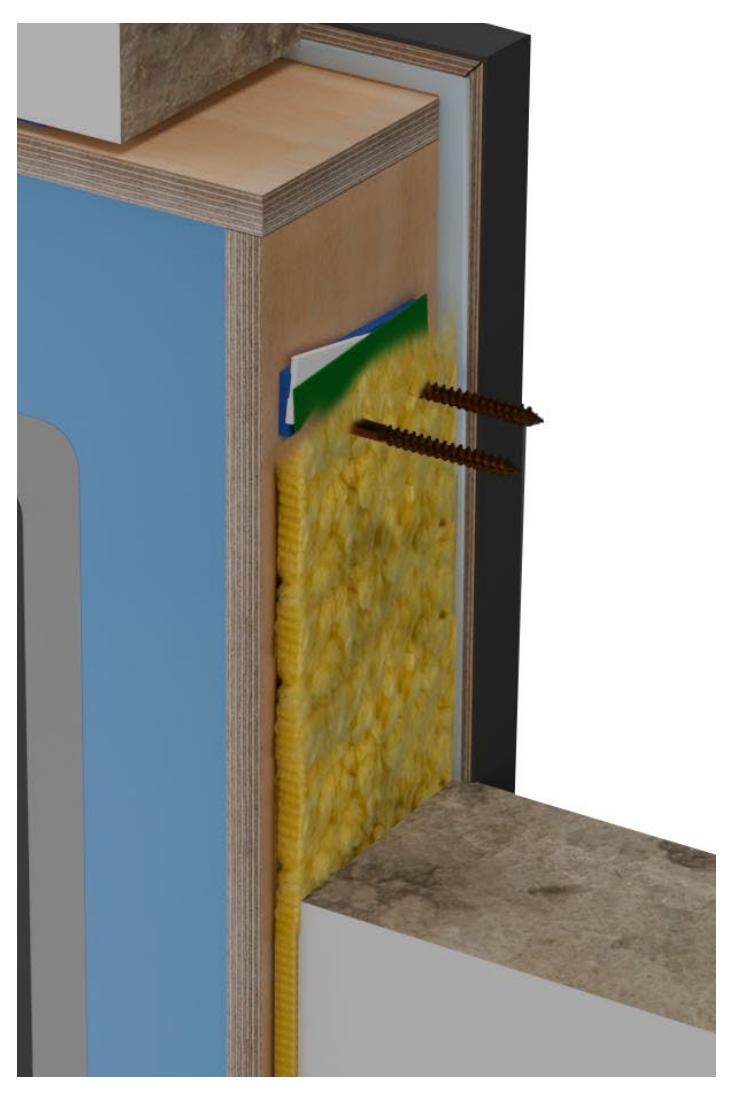
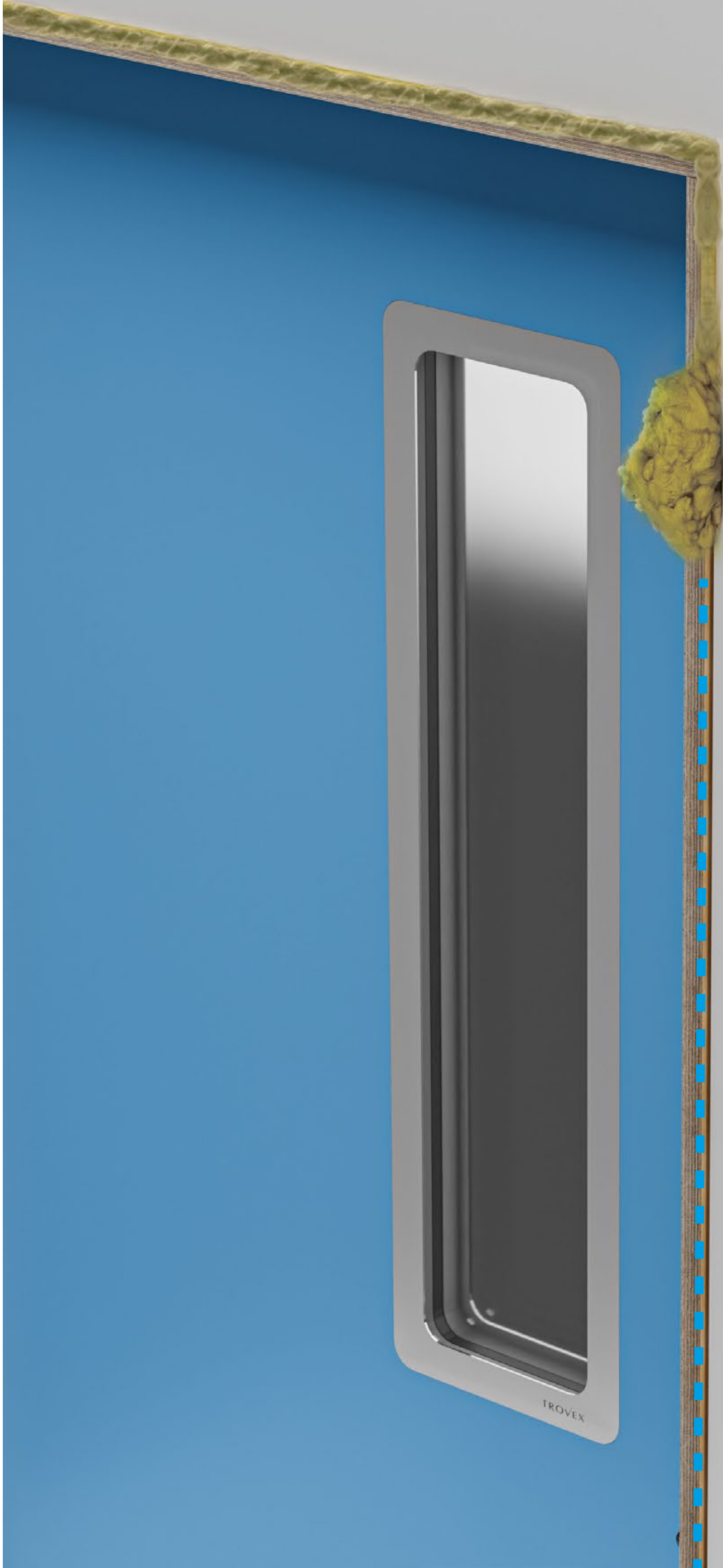

✘ Ensure mineral wool is densely packed and fills the complete void between the opening and frame.

✘ FD60 rated fire-foam can be used for gaps up to 10 mm. Mineral wool can be used for all gaps up 17 mm between frame and substrate. Mineral wool is our recommended fire-stopping material for FD60, however the fire-foam as described is acceptable.

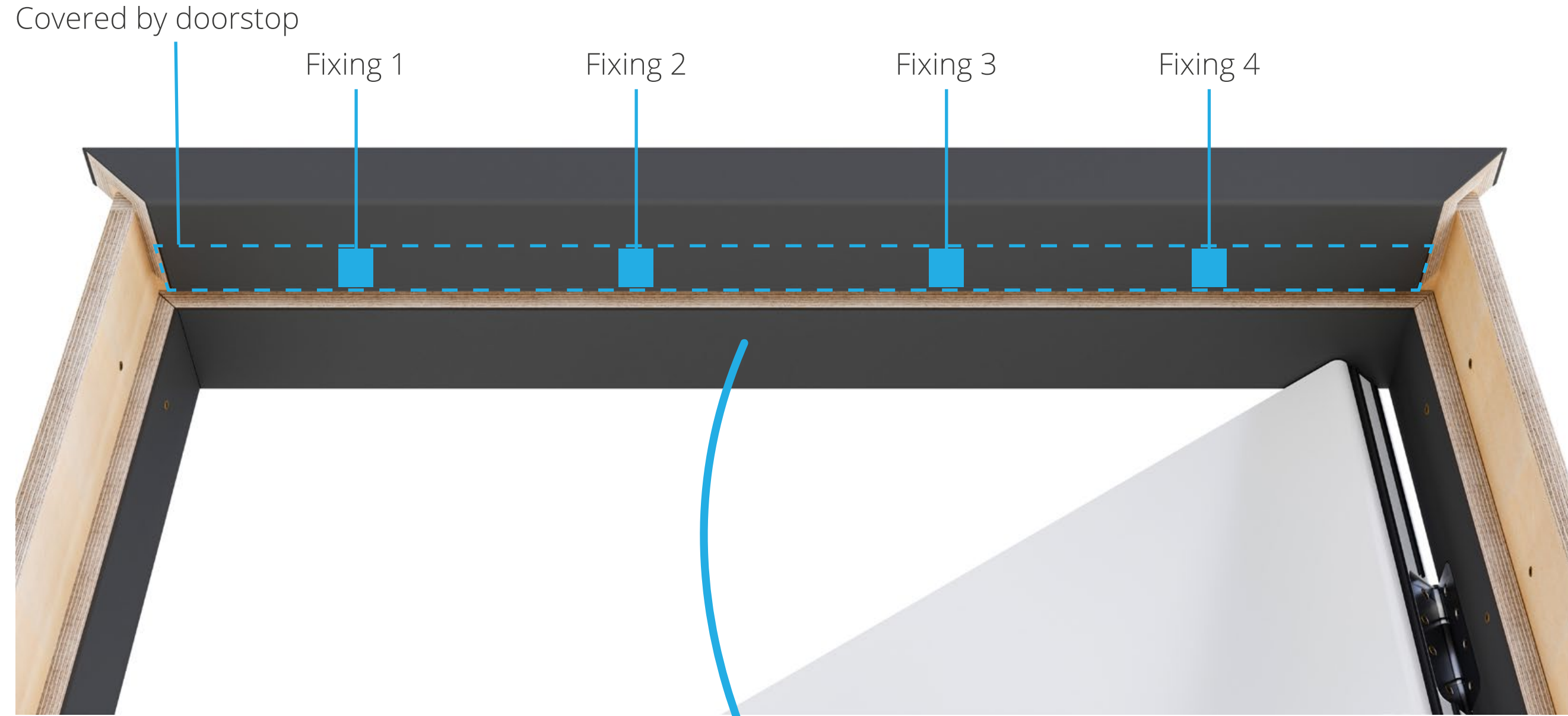

## Install top architrave

Fix the top architrave into position.

Pre-drill at least 4 holes and secure the architrave in place ensuring the fixings will be covered by the door stop.

 Grab a doorstop and establish it's position before fixing the architrave in place.

# Install side architraves

Fix the two side architraves in place.

- Pre-drill at least 5 holes and secure the architrave in place ensuring the fixings will be covered by the door stop.
- Apply the supplied fast set gel to the mitred corner
- Repeat for the second side architrave.

 Grab a doorstop and establish its position before fixing the architrave in place.

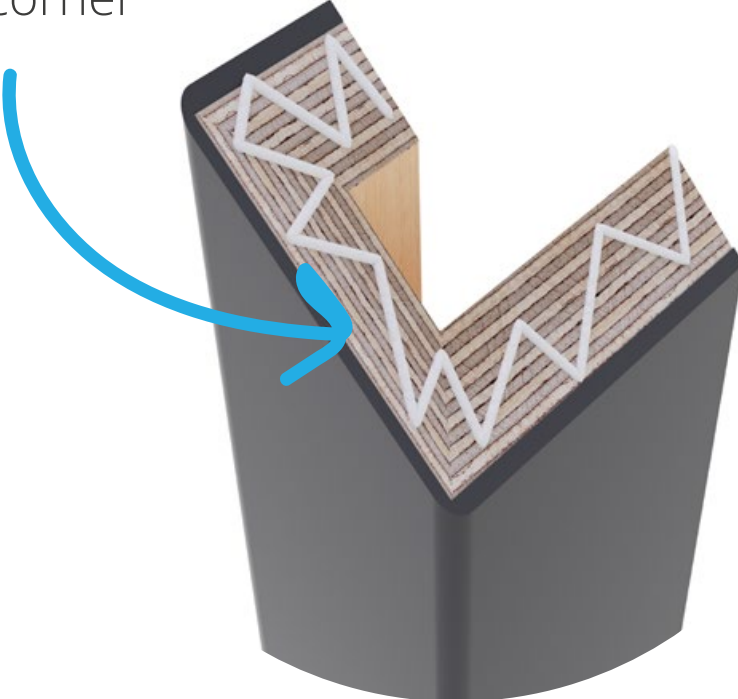

Fixing 1

Fixing 2

Fixing 3

Fixing 4

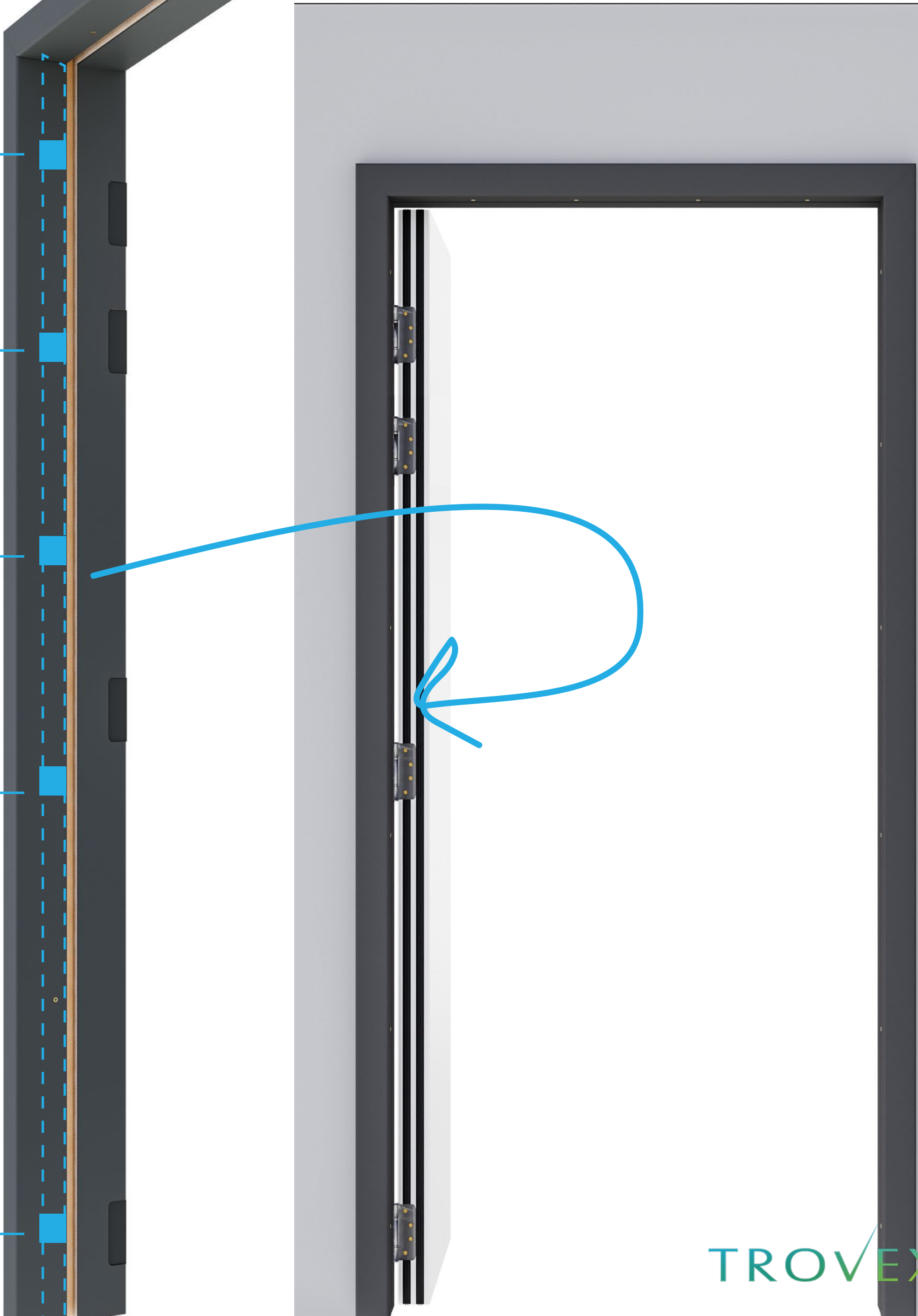

Fixing 5

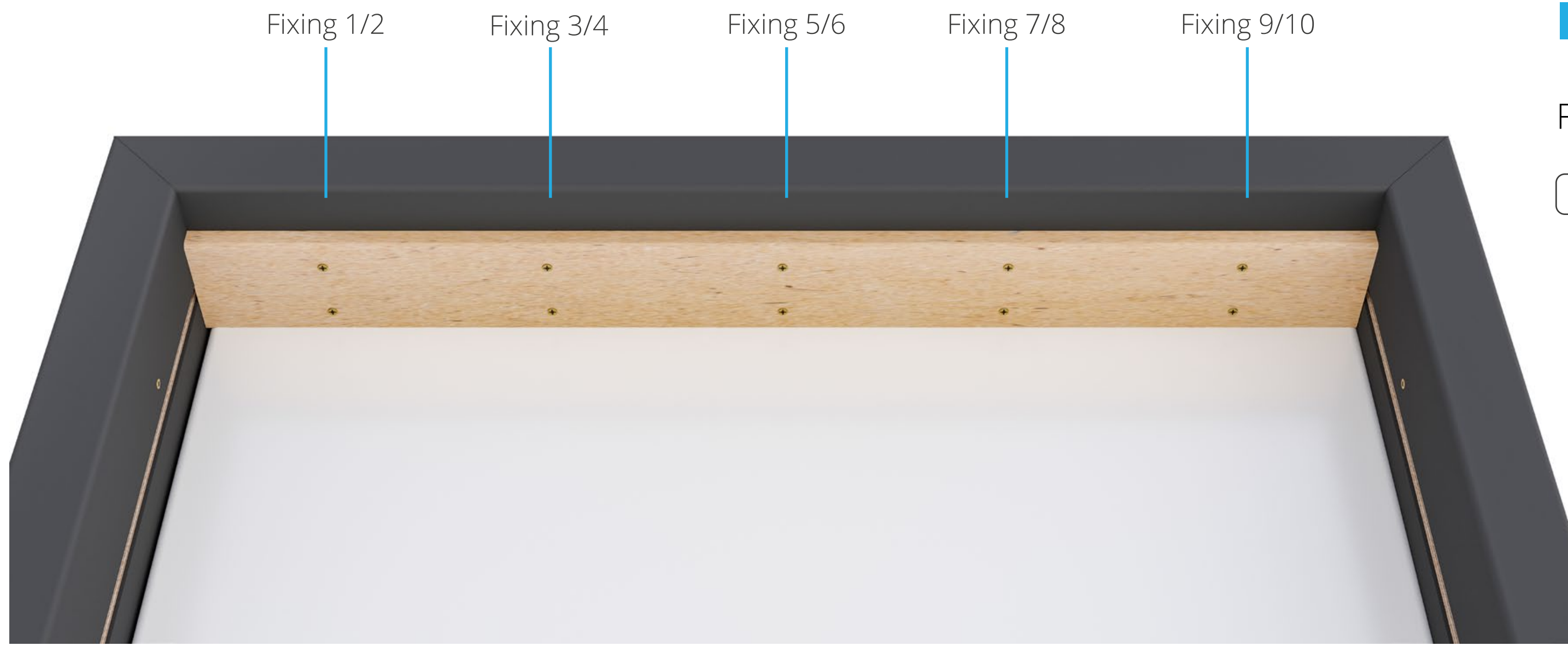



## Install top doorstop

Fix the top doorstop into position.

- Using a 3 mm packer to allow space for doorstop cover between the doorstop and leaf, secure into place using 45 mm screws.
-  We'd recommend installing any locks and lock keeps before fitting the doorstops. (Eliminates any lock rattle).
-  Peel away any protective film prior to fixing the door stop.

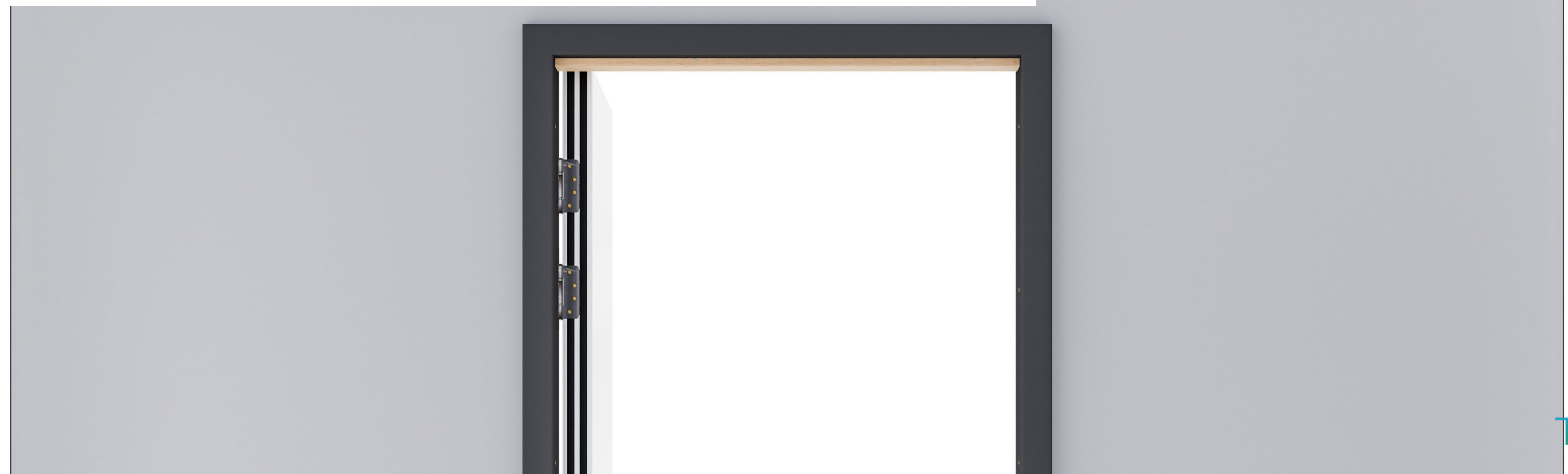

## Fix top doorstop cover

Cover wooden door stop with the doorstop cover.

- In a zigzag pattern apply grab adhesive to the inside of the doorstop cover.
- Firmly press the doorstop cover onto the wood door stop until is secure.

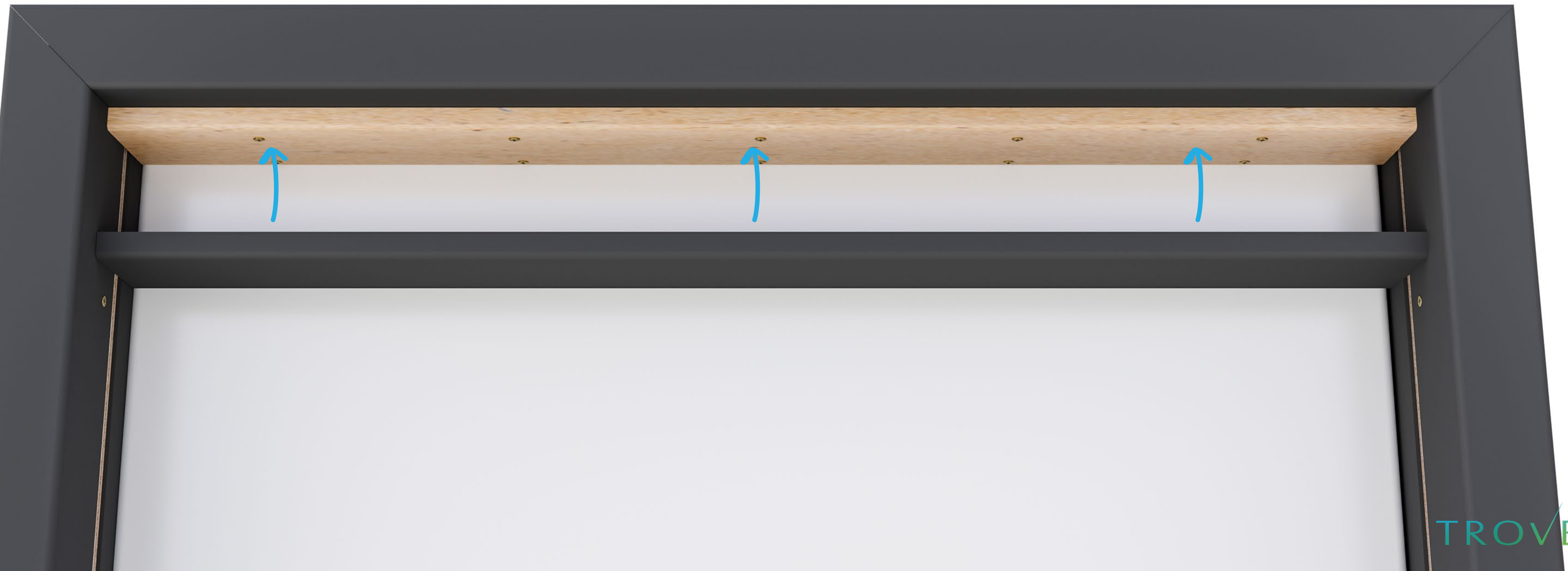

## Install side doorstops

Fix the two side doorstops.

Fix the doorstops using the supplied 50 mm screws.

 Peel away any protective film prior to fixing the door stop.



## Install side doorstop covers

Fix the two side doorstop covers.

- Following the same process as the top doorstop cover, apply Trovex adhesive and firmly press both into place.



## Install ironmongery

Follow ironmongery manufacturers installation guide.

- For handles, push plates and door closers follow the manufacturers installation guidance.
- Apply colour matched sealant where the doorstop cover meets the frame. Apply sealant to match wall colour where the frame meets the substrate





## Post installation

### Cleaning & maintenance

Use a soft, clean cloth dampened with a mild soap or detergent solution. Gently wipe the surface in a circular motion, ensuring to cover all areas. Avoid using abrasive cleaners or tools, as these can scratch the Hygidoor. After cleaning, rinse with clean water and dry thoroughly to prevent water spots or streaks.

For disinfection, use an approved disinfectant suitable for PVC ceramics and metals. Always wear appropriate personal protective equipment when handling cleaning chemicals. It's essential to conduct cleaning and disinfection procedures regularly to reduce the risk of healthcare-associated infections.

### Disposal

Please dispose of all waste materials after installation responsibly using recycling facilities where possible.

### Warranty

The Hygidoor ("the Product") is supplied with a manufacturer's warranty valid for a period of ten (10) years from the date of delivery. This warranty, which is provided by Trovex limited ("the Company"), guarantees that the Product will be free from material defects in design, workmanship, and materials under normal and proper use in accordance with the installation guidance supplied.

Should there be any issues with the Product during the warranty period, the Company commits to either repair or replace the defective product, at our sole discretion, without charge. Please note, this warranty does not cover damage or defects caused by misuse, accident, modification, unsuitable physical or operating environment, improper maintenance, or if the Product has been used in a manner for which it is not intended.

This warranty does not affect statutory rights under UK law. If a problem with this Product develops during or after the warranty period, you may be entitled to certain legal remedies under the UK Sale of Goods Act or the Consumer Rights Act.

For any warranty claims or for more information, please contact our support team.

### Support

For support please contact us on the following:

hello@trovex.com

01707 254 170

Innova House,  
15 Rashes' Green,  
Dereham,  
Norfolk,  
NR19 1JG

TROVEX



[www.trovex.com](http://www.trovex.com)